

# HAGS®



## PARK & URBAN FURNITURE













# CONTENTS

|   |         |
|---|---------|
| <b>Introduction</b>                     | 4 - 7   |
| <b>Sustainability</b>                   | 8 - 11  |
| <b>Solberga Sunlounger</b>              | 12 - 13 |
| <b>Park &amp; Urban Families</b>        |         |
| Rosenlund                               | 16 - 27 |
| Sofiero                                 | 28 - 35 |
| Ekeby                                   | 36 - 41 |
| Zeta                                    | 42      |
| Pixbo                                   | 43      |
| Rörkröken                               | 44      |
| City-Form                               | 45      |
| Birka                                   | 46      |
| Grid                                    | 47      |
| Brahe                                   | 48      |
| Stjerneborg                             | 49      |
| Gripsholm                               | 50      |
| England                                 | 51      |
| <b>Additional Park Benches</b>          | 52 - 55 |
| <b>Picnic Tables</b>                    | 56 - 59 |
| <b>Barbecues &amp; Planters</b>         | 60 - 63 |
| <b>Bins &amp; Ashtrays</b>              | 64 - 67 |
| <b>Bicycle Shelters</b>                 | 68 - 77 |
| <b>Pavilions &amp; Pergolas</b>         | 78 - 79 |
| <b>Outdoor Accessories</b>              | 80 - 81 |
| <b>Shade Systems</b>                    | 82 - 87 |
| <b>Colours &amp; Materials</b>          | 88 - 89 |
| <b>Durability Tests &amp; Materials</b> | 90 - 91 |

Note: Although we do our best to ensure that the colours shown on our website and accompanying material are accurate, actual colours may vary.

We reserve the right to make changes to materials and colours.

## Key to HAGS symbols

|                                     |   |
|-------------------------------------|---|
| <b>Inclusive</b>                    |  |
| <b>Assembly Time (Hours)</b>        |  |
| <b>Space Requirement/Dimensions</b> |  |
| <b>Anchoring Options</b>            |   |
| Sunken Foundation                   |  |
| Cast in Place                       |  |
| Above Ground                        |  |
| Freestanding                        |  |

# PARK & URBAN FURNITURE BY HAGS

The products in our Park & Urban Furniture portfolio are developed in collaboration with renowned Scandinavian designers with the aim of enhancing public areas and creating inviting outdoor living spaces.





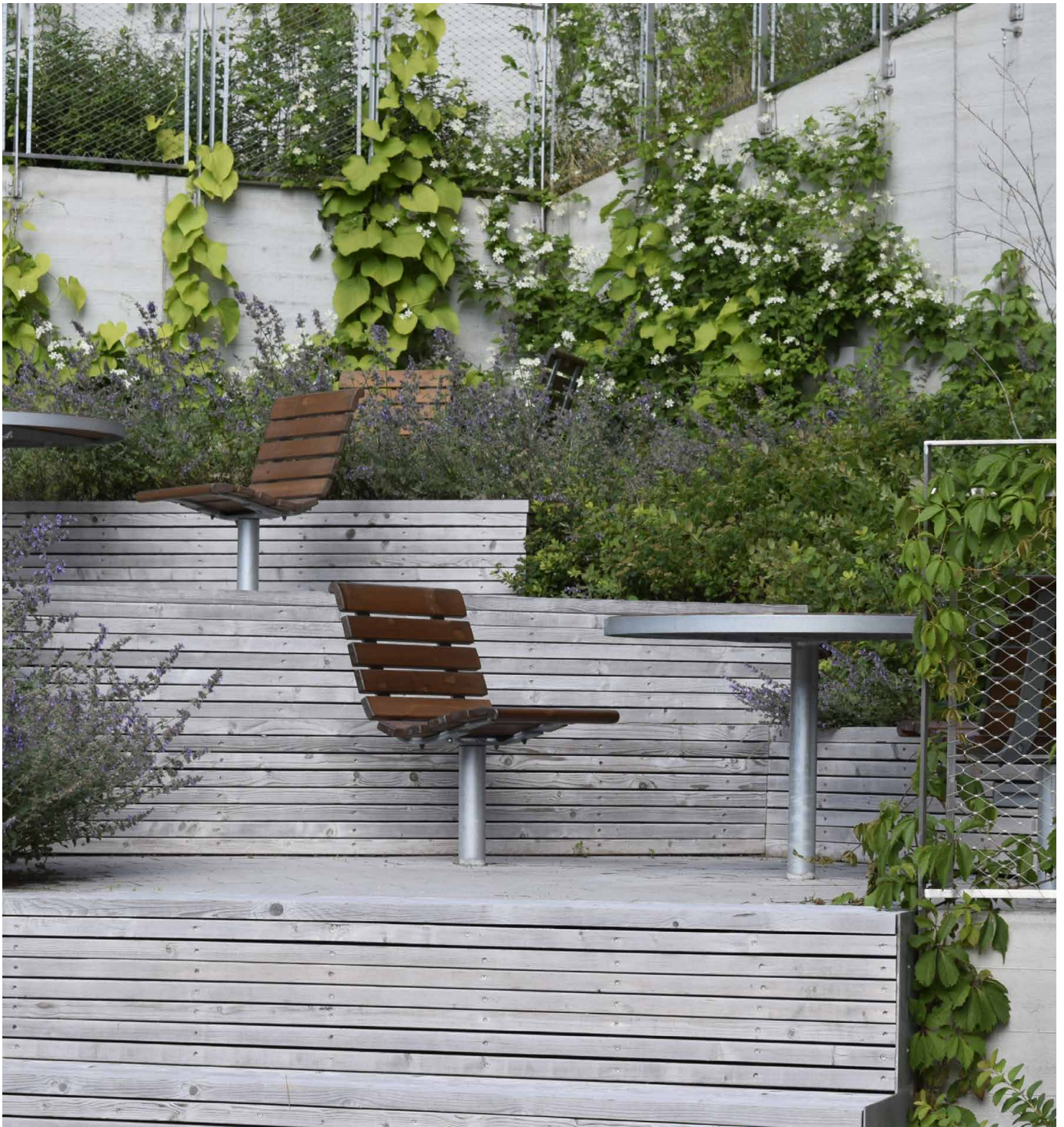

## THE IMPORTANCE OF OUTDOOR SPACES

Parks and public spaces provide significant environmental, aesthetic, and recreational advantages for everyone. We believe it is extremely important that these public spaces are welcoming to people of all ages and abilities.

Outdoor seating provides a comfortable place for people to take a break, meet others or just sit and enjoy the scenery.





# INSPIRING EVERYONE TO ENJOY OUTDOOR SPACES

Inspiration is a feeling of excitement you get from someone or something that inspires you to come up with new and creative ideas.

All our park and urban furniture is manufactured to a high quality. No matter where the outdoor area is located, HAGS furniture is durable, aesthetically pleasing and can be individually assembled according to needs. Our modular park furniture series, in particular, offer countless possibilities.









# SUSTAINABILITY



## 5 in focus!



## HAGS & Sustainability

**At HAGS, we work systematically and continuously to reduce the environmental impact of the company and our products from a life cycle perspective.**

We continuously strive to optimize logistics and transportation, areas within our control that significantly impact environmental sustainability. By doing so, we aim to minimize our carbon footprint and enhance the efficiency of our operations.

A fundamental pillar of our sustainability approach is collaboration. We engage in close cooperation with our suppliers, as well as with our customers and partners. This collaborative effort allows us to enhance our understanding of one another's needs, requirements, and expectations.

To ensure sustainable practices, we closely monitor our suppliers' material selection and production methods. Leveraging the power of product development, we exercise control and influence over the entire process. This enables us to make informed decisions regarding materials, manufacturing techniques, and packaging, with sustainability at the forefront.



In our work we adhere to the United Nations Universal Declaration of Human Rights, the UN Convention on the Rights of the Child, the UN Declaration against Corruption and the eight core conventions of the ILO.

**Our aspiration is to collaborate in building the groundwork for a sustainable society, both for present and all future generations.**

## Product design that supports a circular economy

Our sustainability principles are based on a strong belief in integrating nature into everyday life. Our products are low maintenance and durable.

- Flexible and modular design
- Carefully selected sustainable materials
- Packaging materials that are largely made from recycled or reused materials.















# SOLBERGA

The Solberga sun lounger, with its organic contours and slender lines, offers a sublime, weightless sensation.

Designed for inclusivity, it encourages social engagement outdoors and provides reliable support for the back and legs.

Available in 1 metre or 1.8 metre widths, it offers ample space for group gatherings or peaceful relaxation. It combines functionality and aesthetics for a harmonious and serene experience.

**Design:** Ludvíg Rundlöf



### Solberga Sunlounger 1.0m

8090427 **OM** Dark Brown/Galvanised  
8096733 **CC** Dark Brown/Galvanised  
☛ 1,86 x 1,0 x 0,88



### Solberga Sunlounger 1.0m

8090428 **OM** Dark brown/grey/black  
8096736 **CC** Dark brown/grey/black  
☛ 1,86 x 1,0 x 0,88



### Solberga Sunlounger 1.8m

8090423 **OM** Dark Brown/Galvanised  
8096722 **CC** Dark Brown/Galvanised  
☛ 1,86 x 1,8 x 0,88



### Solberga Sunlounger 1.8m

8090426 **OM** Dark brown/grey/black  
8096732 **CC** Dark brown/grey/black  
☛ 1,86 x 1,8 x 0,88

## MATERIALS AND SURFACES

### Main Material:

Slow-growing Nordic pine (FSC-certified) 28 x 68 mm and 93 x 56 mm.  
Oiled, glazed and covered with matt varnish.  
Standard colour: Dark Brown

### Frame:

Galvanised, lead-free primed and powder-coated or hot-dip galvanised flat steel, 8 mm.  
Standard colour: Galvanised or grey/black  
Other colours available on request.

### Anchoring Options

Above Ground  
Cast in Place



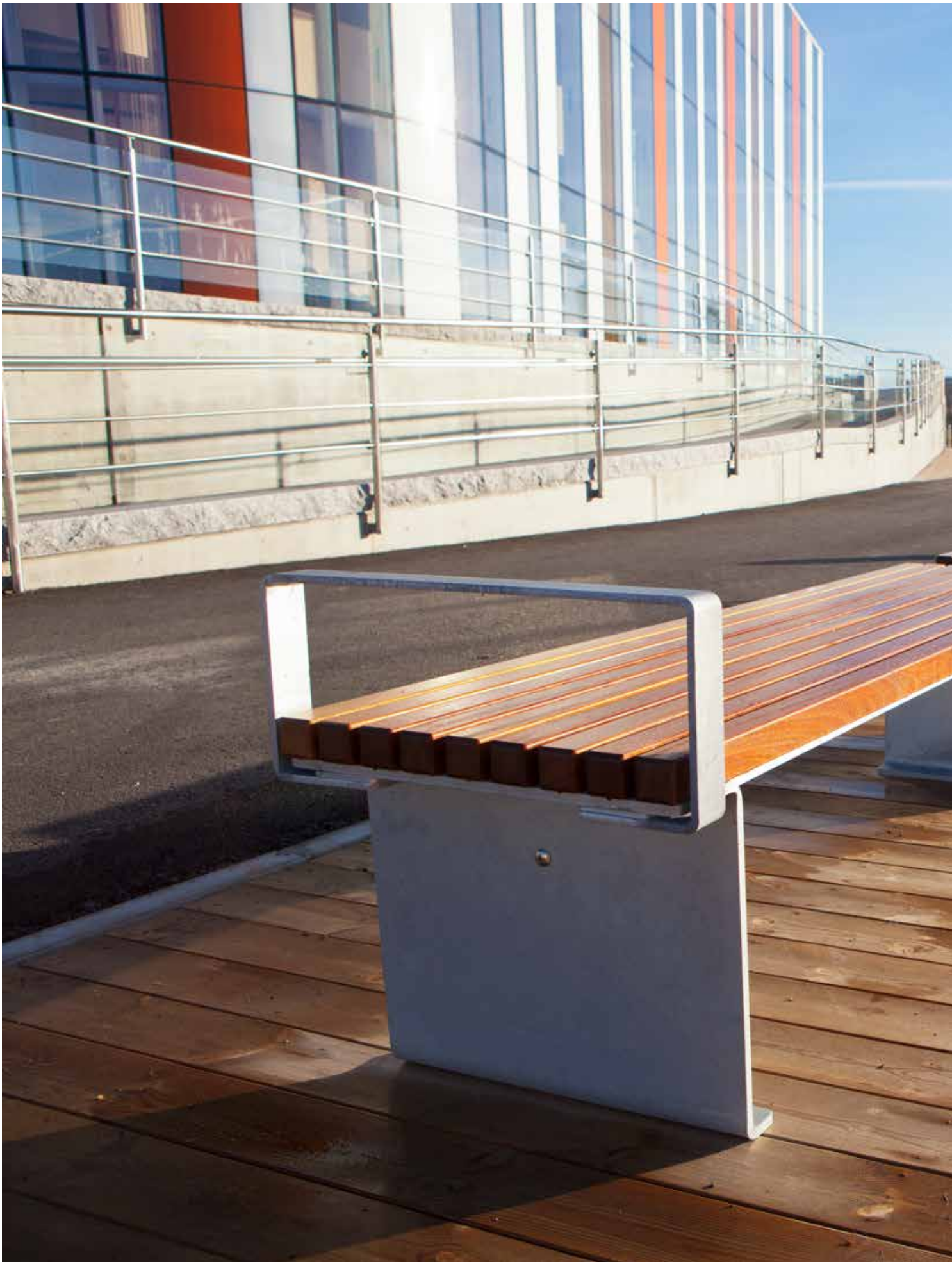



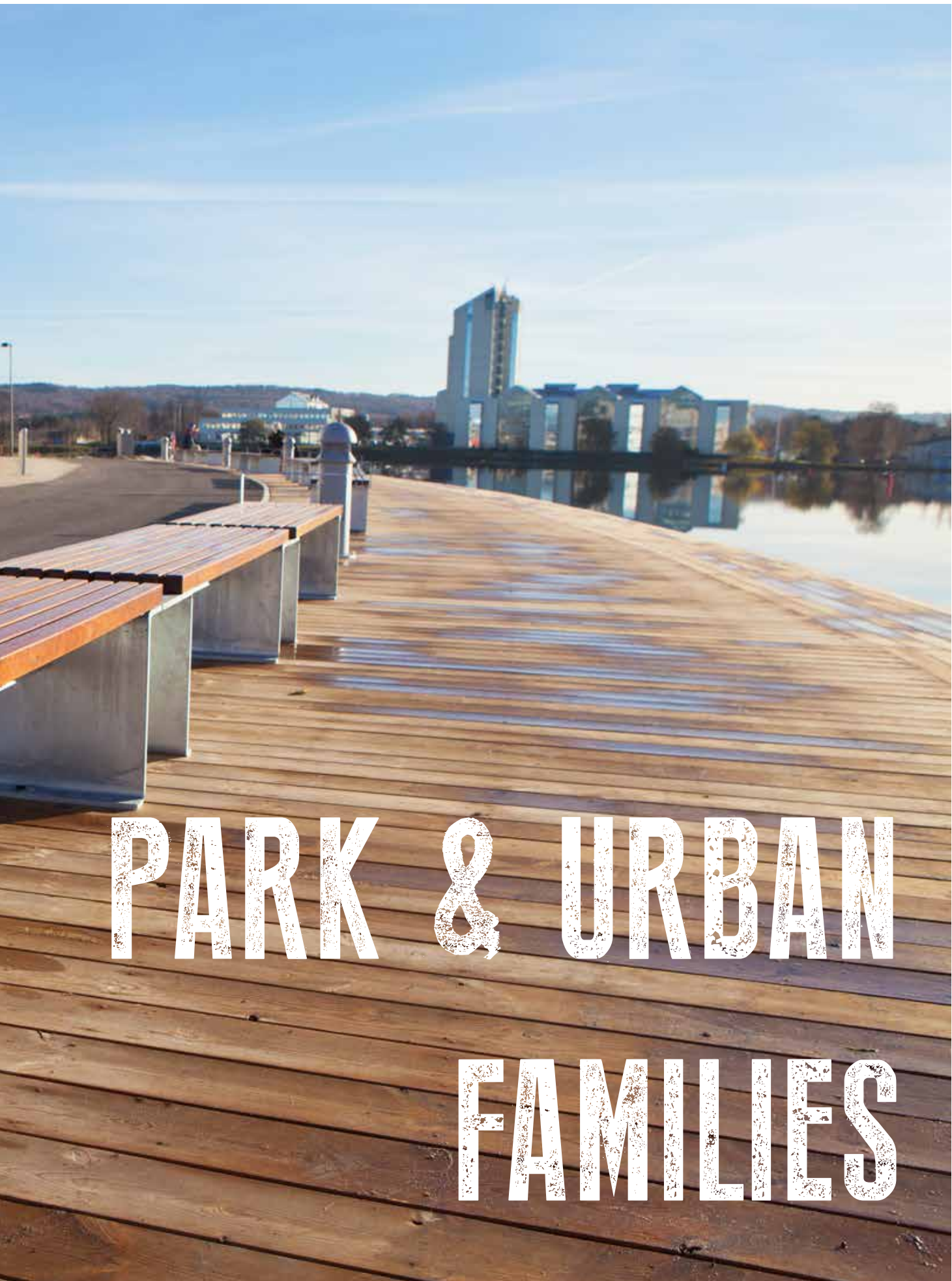

# PARK & URBAN FAMILIES









# ROSENLUND

Rosenlund is a flexible, modular system for creating an attractive interior and exterior communal spaces.

Combine products and colours that match your environment. Park benches, benches and tables, creative trellises and planters that convert into benches, bike racks for the active city and litter bins - there are a multitude of ways to create a colourful gathering place.

The armrests and seat height are designed so that the benches can be used by everyone, regardless of age and ability.

The system allows you to design an area entirely according to your wishes.

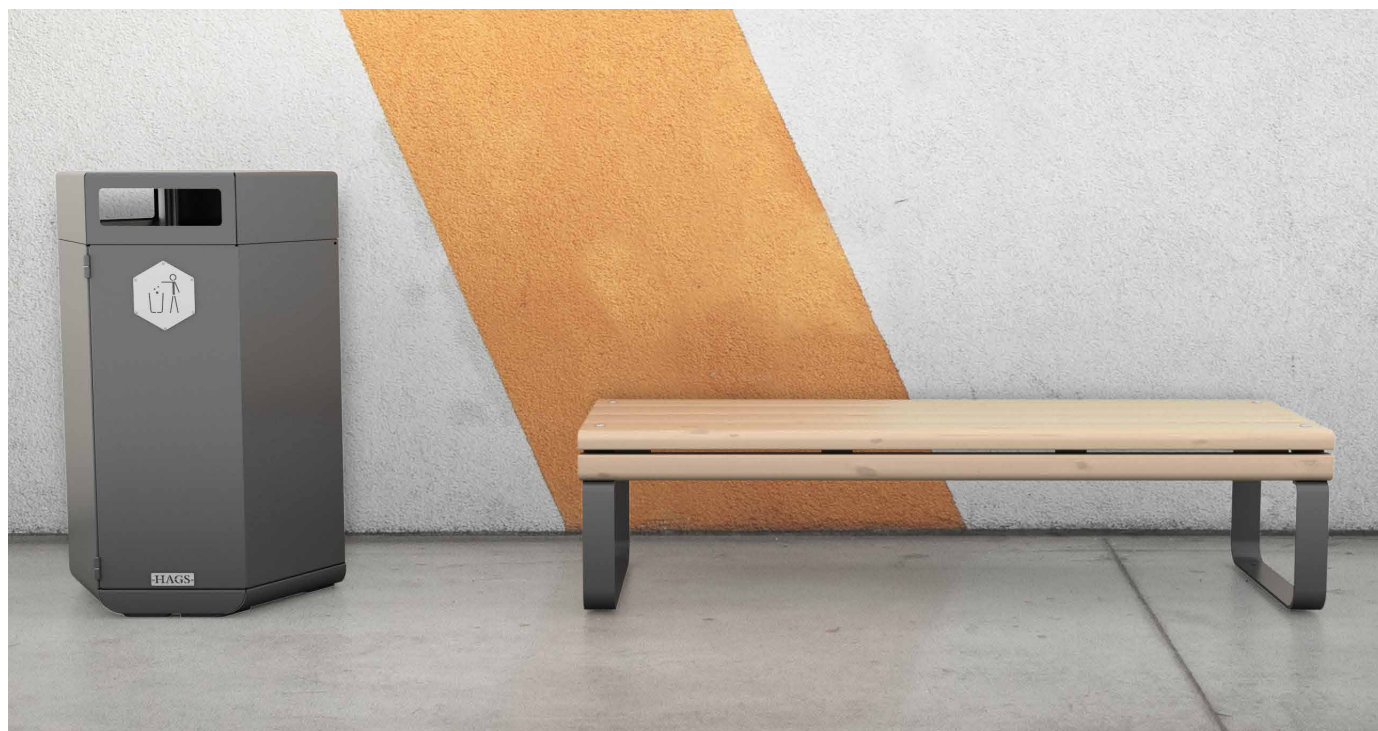

## MATERIALS AND SURFACES

### Main Material:

Slow-growing Nordic pine (FSC-certified), 143 x 45 mm and 65 x 45 mm.

Oiled, glazed and coated with matt lacquer.

Standard colour: Cream white

Alternative Materials: FSC hardwood, oiled (on request).

### Frame:

Galvanised, lead-free primed and powder-coated or hot-dip galvanised flat steel 10 mm or 2 mm (litter bins/planters)

Standard colour: red, green, blue, dark grey or galvanised

Other colours available on request.

### Anchoring Options

Freestanding/Above Ground

Cast in place (only bike rack)





**Rosenlund bench**

- 8076975 **OM** Red
- 8076977 **OM** Green
- 8076978 **OM** Blue
- 8077094 **OM** Dark Grey
- 8076814 **OM** Galvanised
- ☛ 1,76 x 0,6 x 0,45



**Rosenlund bench with armrests**

- 8076979 **OM** Red
- 8076980 **OM** Green
- 8076981 **OM** Blue
- 8077097 **OM** Dark Grey
- 8076896 **OM** Galvanised
- ☛ 1,76 x 0,65 x 0,71



**Rosenlund Park Bench**

- 8076992 **OM** Red
- 8076997 **OM** Green
- 8076998 **OM** Blue
- 8077096 **OM** Dark Grey
- 8076923 **OM** Galvanised
- ☛ 1,76 x 0,6 x 0,84



**Park bench Rosenlund with armrests**

- 8076983 **OM** Red
- 8076984 **OM** Green
- 8076986 **OM** Blue
- 8077095 **OM** Dark Grey
- 8076898 **OM** Galvanised
- ☛ 1,76 x 0,6 x 0,84



**Rosenlund Narrow Table**

- 8077006 **OM** Red
- 8077009 **OM** Green
- 8077011 **OM** Blue
- 8077088 **OM** Dark Grey
- 8076863 **OM** Galvanised
- ☛ 1,76 x 0,6 x 0,74



**Rosenlund Wide Table**

- 8077031 **OM** Red
- 8077032 **OM** Green
- 8077033 **OM** Blue
- 8077091 **OM** Dark Grey
- 8076885 **OM** Galvanised
- ☛ 1,76 x 0,91 x 0,74



**Litter Bin (general waste) 160-180 litres**

- 8080295 **OM** Red
- 8080296 **OM** Green
- 8080297 **OM** Blue
- 8080294 **OM** Dark Grey
- ☛ 0,69 x 0,6 x 1,04



**Litter Bin (glass) 160-180 litres**

- 8081816 **OM** Red
- 8081817 **OM** Green
- 8081818 **OM** Blue
- 8081814 **OM** Dark Grey
- ☛ 0,69 x 0,6 x 1,04



**Litter Bin (recycling/plastic) 160-180 litres**

- 8081809 **OM** Red
- 8081811 **OM** Green
- 8081812 **OM** Blue
- 8081808 **OM** Dark Grey
- ☛ 0,69 x 0,6 x 1,04



**Bicycle Racks**

- 8079166 **OM** Red
- 8079167 **OM** Green
- 8079168 **OM** Blue
- 8079165 **OM** Dark Grey
- 8079163 **OM** Galvanised
- ☛ 0,53 x 0,32 x 0,88 OM: Above Ground



**Bicycle Racks**

- 8079171 **CC** Red
- 8079172 **CC** Green
- 8079173 **CC** Blue
- 8079170 **CC** Dark Grey
- 8079169 **CC** Galvanised
- ☛ 0,53 x 0,32 x 0,88 CC: Cast in Place



## Table/bench modules

Maximise your outdoor space with our modular benches and narrow tables.

These modular versions are available either with one leg or completely without, so that they can be mounted on the Rosenlund planters. Available with or without armrests.

With Rosenlund you have the flexibility to create your own layout.



**Rosenlund Narrow Table Extension** without legs  
8080069  
☛ 1,76 x 0,60 x 0,1



**Rosenlund Narrow Table Extension** with leg  
8080076 **OM** Red  
8080077 **OM** Green  
8080078 **OM** Blue  
8080079 **OM** Dark Grey  
8080075 **OM** Galvanised  
☛ 1,76 x 0,6 x 0,74



**Rosenlund Bench Extension** with leg  
8080111 **OM** Red  
8080112 **OM** Green  
8080113 **OM** Blue  
8080114 **OM** Dark Grey  
8080110 **OM** Galvanised  
☛ 1,76 x 0,6 x 0,45



**Rosenlund Bench Extension** with leg/armrest  
8080118 **OM** Red  
8080119 **OM** Green  
8080120 **OM** Blue  
8080121 **OM** Dark Grey  
8080117 **OM** Galvanised  
☛ 1,76 x 0,6 x 0,71



**Rosenlund Park Bench Extension** without legs/armrest  
8080199 **OM** Red  
8080201 **OM** Green  
8080202 **OM** Blue  
8080203 **OM** Dark Grey  
8080198 **OM** Galvanised  
☛ 1,76 x 0,6 x 0,84



**Rosenlund Park Bench Extension** with armrests  
8080211 **OM** Red  
8080212 **OM** Green  
8080213 **OM** Blue  
8080214 **OM** Dark Grey  
8080210 **OM** Galvanised  
☛ 1,76 x 0,6 x 0,84



**Rosenlund Park Bench Extension** with leg/armrests  
8080164 **OM** Red  
8080165 **OM** Green  
8080166 **OM** Blue  
8080167 **OM** Dark Grey  
8080163 **OM** Galvanised  
☛ 1,76 x 0,65 x 0,84



**Rosenlund Park Bench Extension** with leg, without armrest  
8080186 **OM** Red  
8080187 **OM** Green  
8080188 **OM** Blue  
8080189 **OM** Dark Grey  
8080185 **OM** Galvanised  
☛ 1,76 x 0,60 x 0,84



**Rosenlund Park Bench Extension** with leg/armrest  
8080174 **OM** Red  
8080175 **OM** Green  
8080176 **OM** Blue  
8080177 **OM** Dark Grey  
8080173 **OM** Galvanised  
☛ 1,76 x 0,65 x 0,84







## Rosenlund Modular System - Planters & Informal Seating Groups

These elegant and stylish planters look stunning both outdoors and indoors.

Their simple design helps to draw attention to and highlight the natural beauty of the plants. We offer a range of shapes, colours and sizes to suit your environment. With compatible modules, they can also be transformed into seating and can be attached to Rosenlund benches and narrow tables. A raised module can be added to the planters to adjust the height.

### Modules

#### 1. Trellis

Quick and easy to install, this slender trellis provides support for your plants and creates a wonderful eye-catcher. With several trellises, the system is suitable as a partition to divide up spaces.

#### 2. Seating

Turn your planter into a seating area by simply adding a seat. Available in different shapes and sizes to match our Rosenlund planters.

#### 3. Wooden frame

The wooden frame adds a touch of style to your planter and loosens up the appearance. This component is essential when designing planters. Available in various shapes and sizes to match our Rosenlund planters.

#### 4. Elevation module

This module is perfect for raising the planters and turning it into a table or a high seat. Available in different shapes, sizes and colours to match our Rosenlund planters.

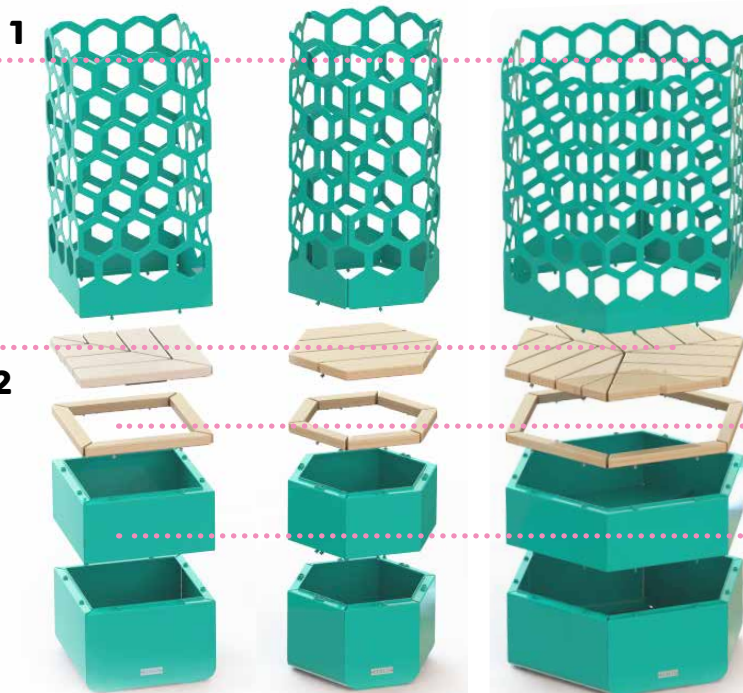

Square Planter

Hexagon Planter Small

Hexagon Planter Large





**Rosenlund Square Planter**

- 8079506 OM Red
- 8079507 OM Green
- 8079508 OM Blue
- 8079505 OM Dark Grey
- 8079504 OM Galvanised

☛ 0,6 x 0,6 x 0,4



**Rosenlund Hexagon Planter Small**

- 8079522 OM Red
- 8079523 OM Green
- 8079524 OM Blue
- 8079521 OM Dark Grey
- 8079520 OM Galvanised

☛ 0,69 x 0,6 x 0,4



**Rosenlund Hexagon Planter Large**

- 8079250 OM Red
- 8079251 OM Green
- 8079252 OM Blue
- 8079249 OM Dark Grey
- 8079248 OM Galvanised

☛ 1,2 x 1,04 x 0,4



**Rosenlund Square Extension**

- 8079667 OM Red
- 8079668 OM Green
- 8079669 OM Blue
- 8079665 OM Dark Grey
- 8079664 OM Galvanised

☛ 0,6 x 0,6 x 0,29



**Rosenlund Hexagon Extension**

- 8079561 OM Red
- 8079562 OM Green
- 8079563 OM Blue
- 8079560 OM Dark Grey
- 8079559 OM Galvanised

☛ 0,69 x 0,6 x 0,29



**Rosenlund Hexagon Extension Large**

- 8079363 OM Red
- 8079364 OM Green
- 8079365 OM Blue
- 8079362 OM Dark Grey
- 8079361 OM Galvanised

☛ 1,2 x 1,04 x 0,29

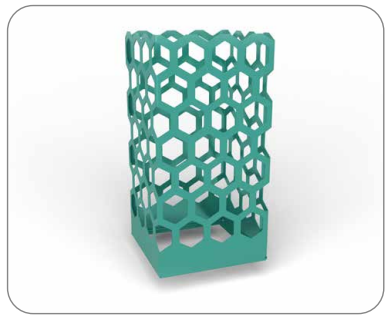

**Rosenlund Square Trellis**

- 8079462 OM Red
- 8079463 OM Green
- 8079464 OM Blue
- 8079461 OM Dark Grey
- 8079460 OM Galvanised

☛ 0,6 x 0,6 x 1,18

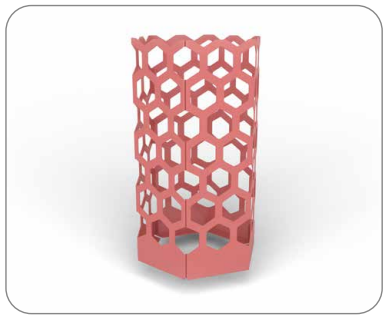

**Rosenlund Small Hexagon Trellis**

- 8079442 OM Red
- 8079443 OM Green
- 8079444 OM Blue
- 8079441 OM Dark Grey
- 8079440 OM Galvanised

☛ 0,69 x 0,6 x 1,18

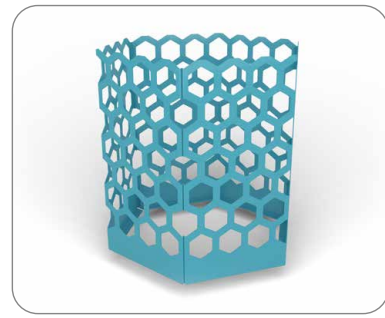

**Rosenlund Large Hexagon Trellis**

- 8079409 OM Red
- 8079410 OM Green
- 8079411 OM Blue
- 8079408 OM Dark Grey
- 8079407 OM Galvanised

☛ 1,19 x 1,04 x 1,18



**Rosenlund Square Frame**

- 8079635 Cream white

☛ 0,6 x 0,6 x 0,06



**Rosenlund Small Hexagon Frame**

- 8079614 Cream white

☛ 0,68 x 0,6 x 0,06



**Rosenlund Large Hexagon Frame**

- 8079352 Cream white

☛ 1,19 x 1,04 x 0,06





**Rosenlund Square Seat**

8079649  
 ⌀ 0,6 x 0,6 x 0,06



**Rosenlund Small Hexagon Seat**

8079585  
 ⌀ 0,68 x 0,6 x 0,06



**Rosenlund Large Hexagon Seat**

8079333  
 ⌀ 1,2 x 1,04 x 0,06



**Rosenlund Half Hexagon Planter**

8098837 **OM** Red  
 8098838 **OM** Green  
 8098840 **OM** Blue  
 8098836 **OM** Dark Grey  
 8098588 **OM** Galvanised  
 ⌀ 1,2 x 0,52 x 0,4



**Rosenlund Half Hexagon Extension**

8098907 **OM** Red  
 8098908 **OM** Green  
 8098909 **OM** Blue  
 8098902 **OM** Dark Grey  
 8098590 **OM** Galvanised  
 ⌀ 1,2 x 0,52 x 0,3

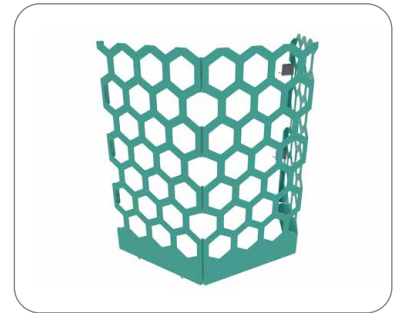

**Rosenlund Half Hexagon Trellis**

8100814 **OM** Red  
 8100815 **OM** Green  
 8100816 **OM** Blue  
 8100813 **OM** Dark Grey  
 8098591 **OM** Galvanised  
 ⌀ 1,19 x 0,52 x 1,17



**Rosenlund Half Hexagon Frame**

8098594  
 ⌀ 1,2 x 0,52 x 0,06



**Rosenlund Half Hexagon Seat**

8098592  
 ⌀ 1,2 x 0,52 x 0,06



# Accessories

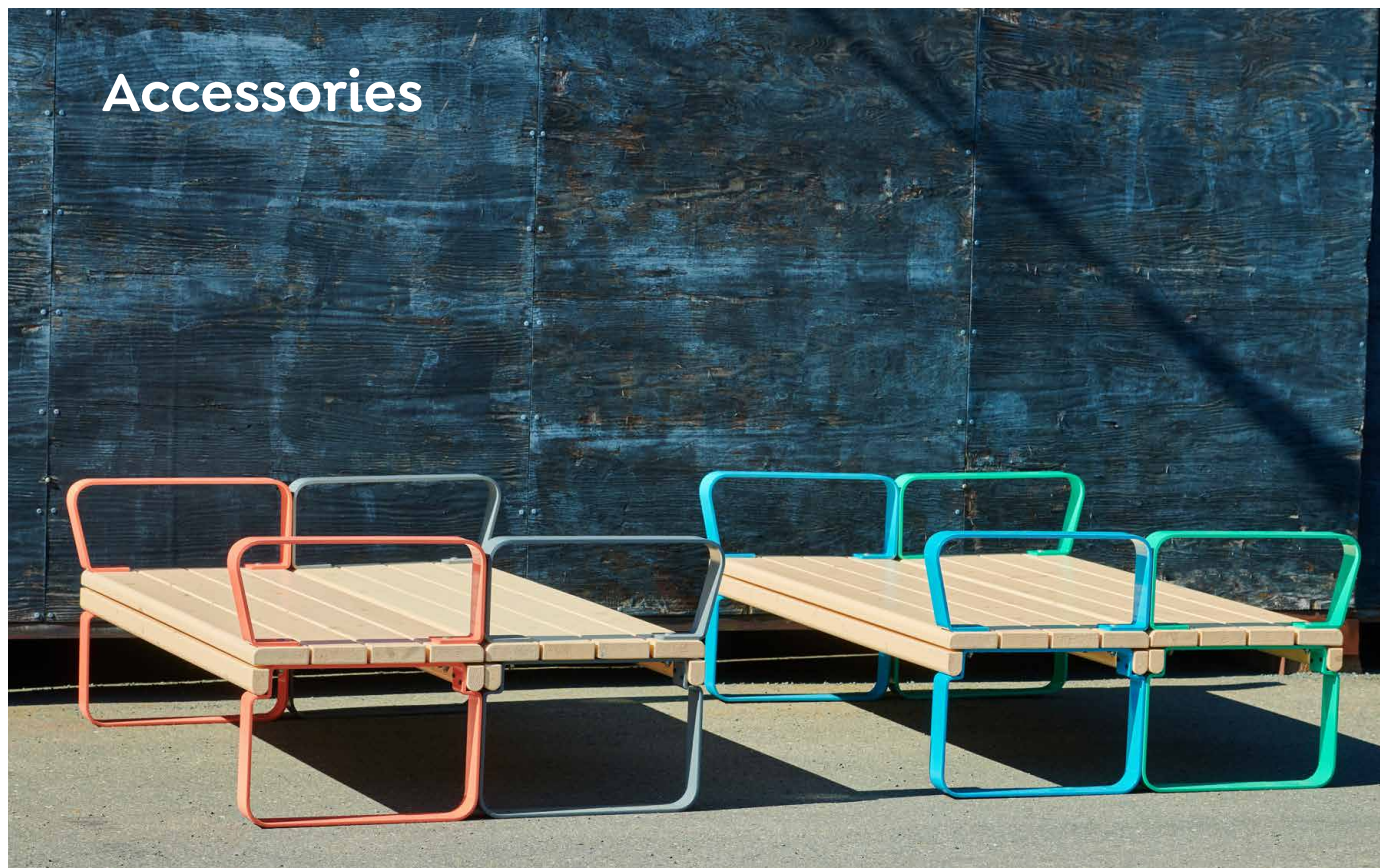

Complement your Rosenlund furniture with practical accessories and provide users with additional comfort.



**Rosenlund Backrest Short Bench**

- 8099536 *Red*
- 8099537 *Green*
- 8099539 *Blue*
- 8099540 *Dark Grey*
- 8099533 *Galvanised*

⦿ 0,65 x 0,13 x 0,4

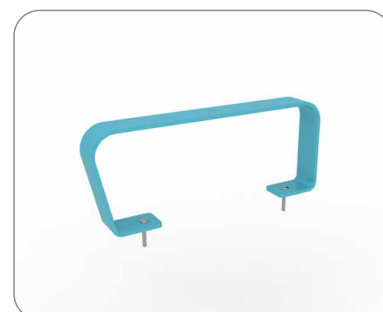

**Armrest** for Rosenlund Bench

- 8080134 *Red*
- 8080135 *Green*
- 8080136 *Blue*
- 8080137 *Dark Grey*
- 8080133 *Galvanised*

⦿ 0,65 x 0,08 x 0,26



**Rosenlund Hexagon Backrest**

- 8099442 *Red*
- 8099443 *Green*
- 8099444 *Blue*
- 8099445 *Dark Grey*
- 8098586 *Galvanised*

⦿ 0,6 x 0,13 x 0,4



**Rosenlund Mini Table** to attach

- 8077038 *Red*
- 8077042 *Green*
- 8077044 *Blue*
- 8077098 *Dark Grey*
- 8076934 *Galvanised*

⦿ 0,3 x 0,26 x 0,26

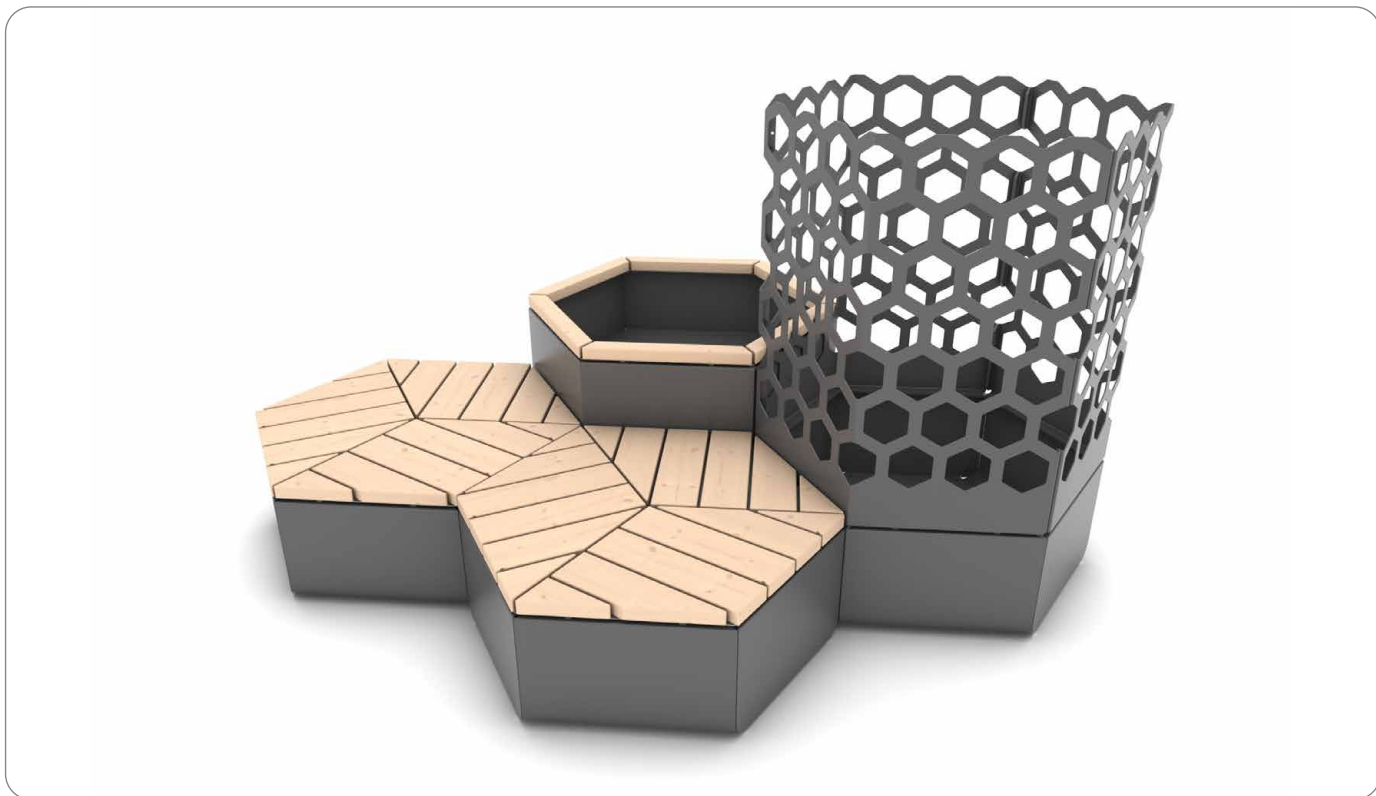

**Rosenlund Hexagon Combination 1**

8096430 *Blue*  
8096431 *Dark Grey*  
☛ 2,6 x 2,1

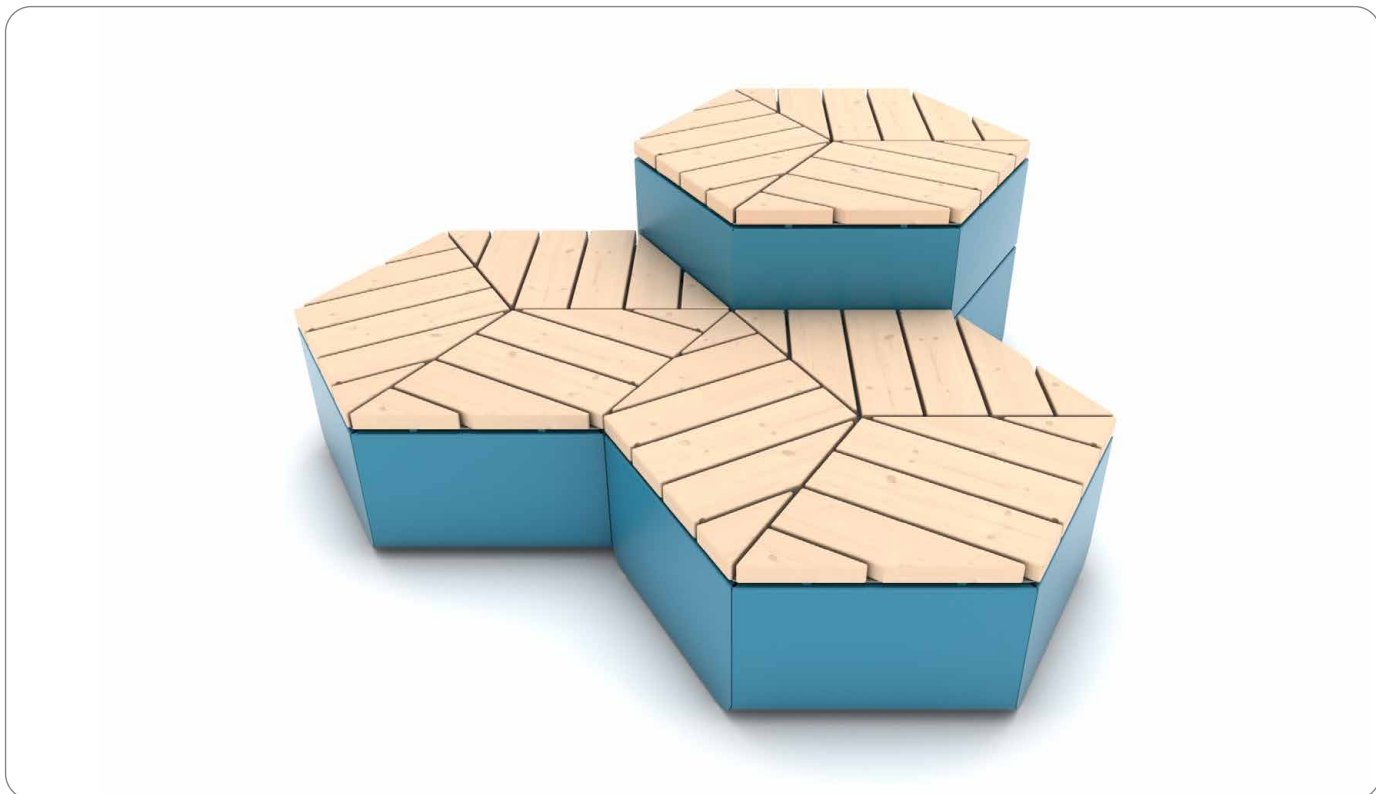

**Rosenlund Hexagon Combination 2**

8096426 *Blue*  
8096429 *Dark Grey*  
☛ 2,1 x 2,1



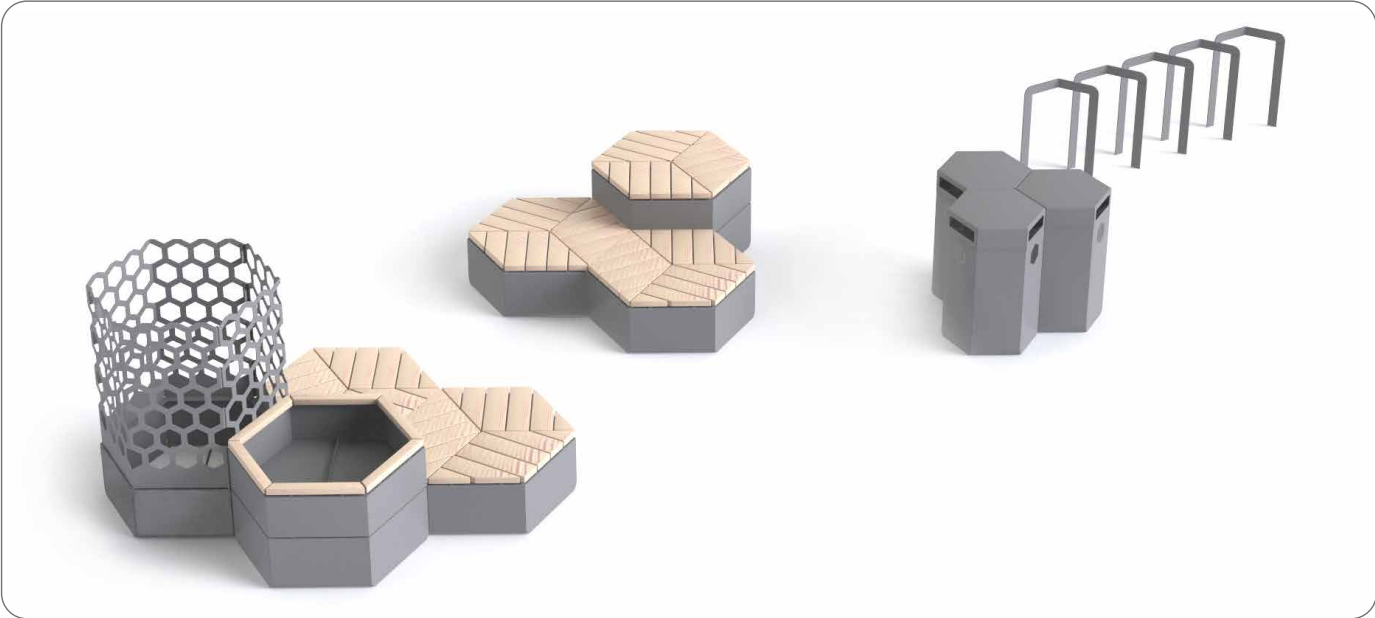
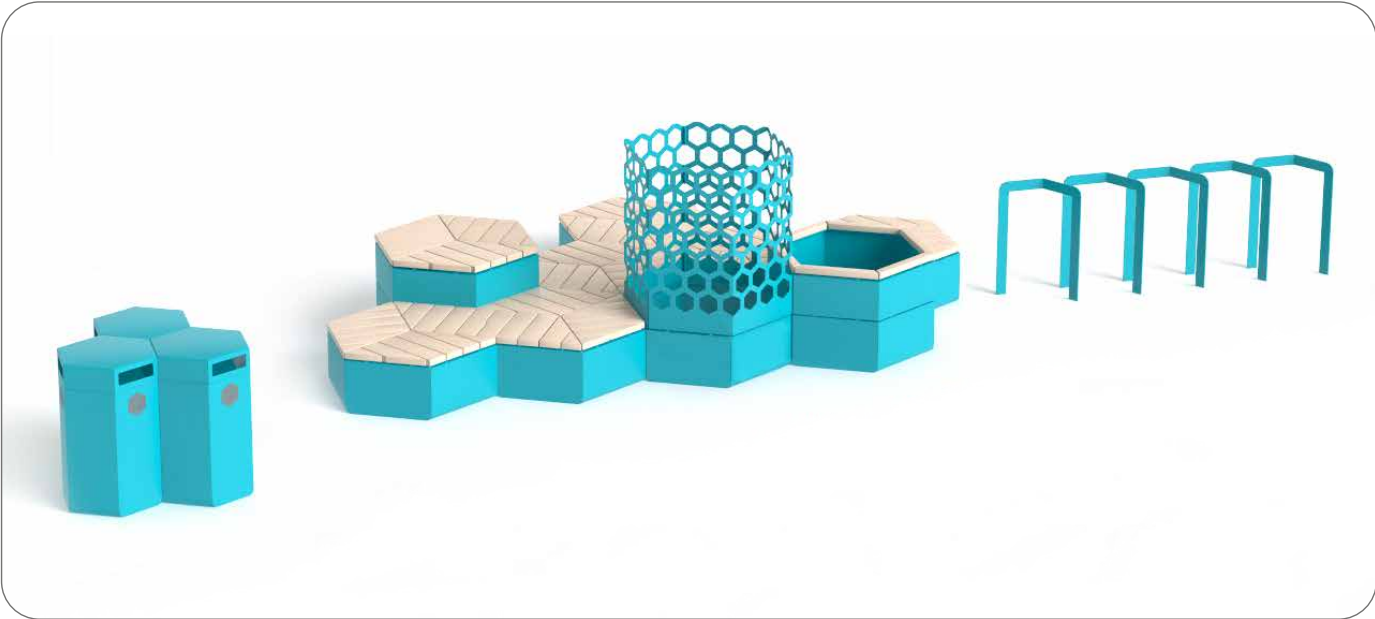

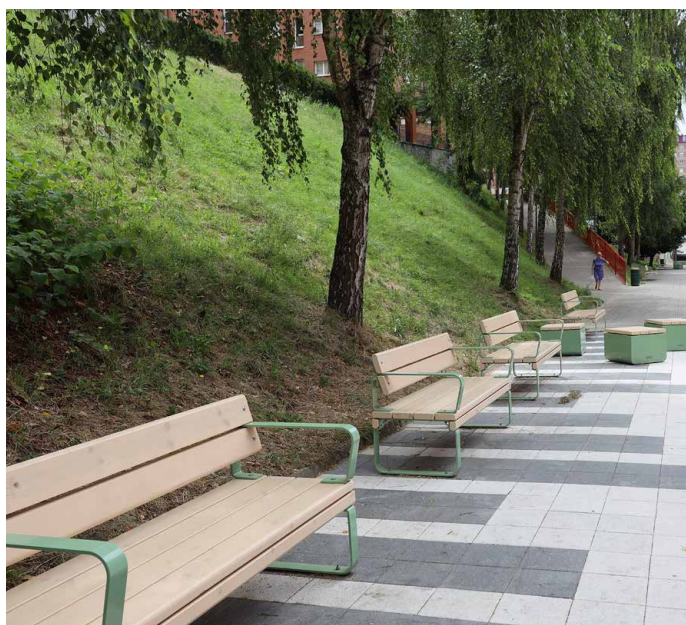











# SOFIERO

The Sofiero modular park furniture series offers a timeless and harmonious design. It is simple, elegant and comfortable by nature and enhances any outdoor space.

You can combine the products according to your own needs and create new wonderful meeting places.

Sofiero was developed in collaboration with renowned architect and industrial designer Jan Wickelgren and designed with comfort, style and modularity in mind. "The idea behind the design of Sofiero was to create a versatile, timeless series that gives architects and urban planners the flexibility to create vibrant and inclusive public spaces," Jan explains.

**Designer:** Jan Wickelgren

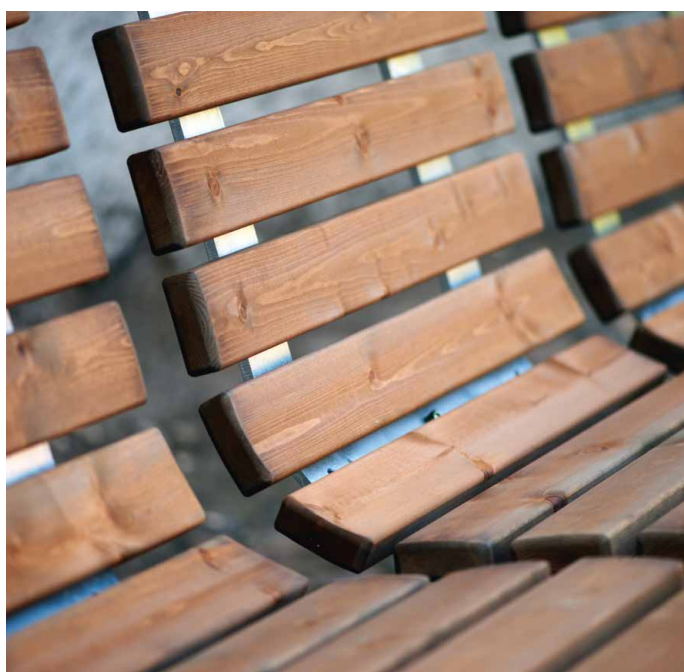
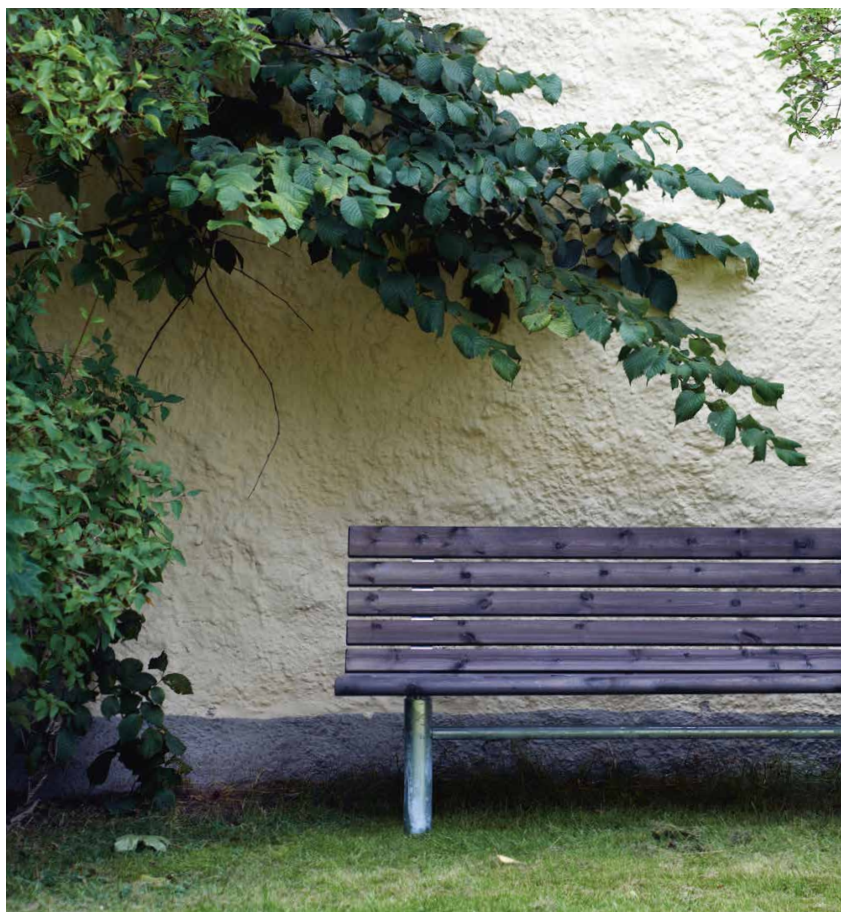

## MATERIALS AND SURFACES

### Main Material:

Slow-growing Nordic pine (FSC-certified), 28 x 68 mm.

Oiled, glazed and coated with matt lacquer.

Standard colour: Dark brown or green

Alternative Materials: FSC hardwood, oiled.

### Frame:

Galvanised, lead-free primed and powder-coated or hot-dip galvanised steel tube, Ø 76 mm and flat steel, 60 x 8 mm.

Standard colour: Black or Galvanised

Other colours available on request.

### Anchoring Options

Freestanding/Above Ground

Cast in Place

Cast in Place with optional ground anchoring kit

# Sofiero



**Sofiero Bench** Nordic Pine

- 8037021 **CC** Dark Brown/Black
  - 8037027 **F** Dark Brown/Black
  - 8037022 **CC** Dark Brown/Galvanised
  - 8037028 **F** Dark Brown/Galvanised
- ☛ 1,76 x 0,35 x 0,45



**Sofiero Park Bench** Nordic Pine

- 8037008 **CC** Dark Brown/Black
  - 8037012 **F** Dark Brown/Black
  - 8037009 **CC** Dark Brown/Galvanised
  - 8037014 **F** Dark Brown/Galvanised
- ☛ 1,76 x 0,61 x 0,81



**Sofiero Seat** Nordic Pine

- 8040023 **CC** Dark brown/black - rotatable
  - 8037034 **CC** Dark brown/black - fixed
  - 8037033 **CC** Dark brown/galvanised - rotatable
  - 8037032 **CC** Dark brown/galvanised - fixed
- ☛ 0,58 x 0,61 x 0,81



**Bench Sofiero** FSC Hardwood

- 8058466 **CC** Brown/Black
  - 8058467 **F** Brown/Black
  - 8058450 **CC** Brown/Galvanised
  - 8058451 **F** Brown/Galvanised
- ☛ 1,76 x 0,35 x 0,45



**Park bench Sofiero** FSC Hardwood

- 8058464 **CC** Brown/Black
  - 8058465 **F** Brown/Black
  - 8058448 **CC** Brown/Galvanised
  - 8058464 **F** Brown/Galvanised
- ☛ 1,76 x 0,61 x 0,81



**Armchair Sofiero** FSC Hardwood

- 8058471 **CC** Brown/Black - rotatable
  - 8058470 **F** Brown/Black - fixed
  - 8058455 **CC** Brown/galvanised - rotatable
  - 8058454 **F** Brown/Galvanised - fixed
- ☛ 0,58 x 0,61 x 0,81



**Table Sofiero round Ø1100** Nordic Pine

- 8080023 **CC** Dark Brown/Black
  - F** Dark brown/black - On request
  - 8054271 **CC** Dark Brown/Galvanised
  - 8054274 **F** Dark Brown/Galvanised
- ☛ 1,1 x 1,1 x 0,7



**Table Sofiero Round Mini Ø600** Nordic Pine

- 8073769 **CC** Dark Brown/Black
  - 8073765 **F** Dark Brown/Black
  - 8072817 **CC** Dark Brown/Galvanised
  - 8072824 **F** Dark Brown/Galvanised
- ☛ 0,6 x 0,6 x 0,7



**Table Sofiero angular** Nordic Pine

- 8037044 **CC** Dark Brown/Black
  - 8037049 **F** Dark Brown/Black
  - 8037046 **CC** Dark Brown/Galvanised
  - 8037050 **F** Dark Brown/Galvanised
- ☛ 1,3 x 0,7 x 0,7



**Sofiero Round Table Ø1100** FSC Hardwood

- CC** Brown/Black On request
  - F** Brown/Black - On request
  - 8058456 **CC** Brown/Galvanised
  - 8058081 **F** Brown/Galvanised
- ☛ 1,1 x 1,1 x 0,7



**Sofiero Round Mini Table Ø600** FSC Hardwood

- 8097532 **CC** Brown/Black
  - 8097534 **F** Brown/Black
  - 8097531 **CC** Brown/Galvanised
  - 8097533 **F** Brown/Galvanised
- ☛ 0,6 x 0,6 x 0,7



**Sofiero Angular Table** FSC Hardwood

- 8058468 **CC** Brown/Black
  - 8058469 **F** Brown/Black
  - 8058452 **CC** Brown/Galvanised
  - 8058453 **F** Brown/Galvanised
- ☛ 1,3 x 0,7 x 0,7



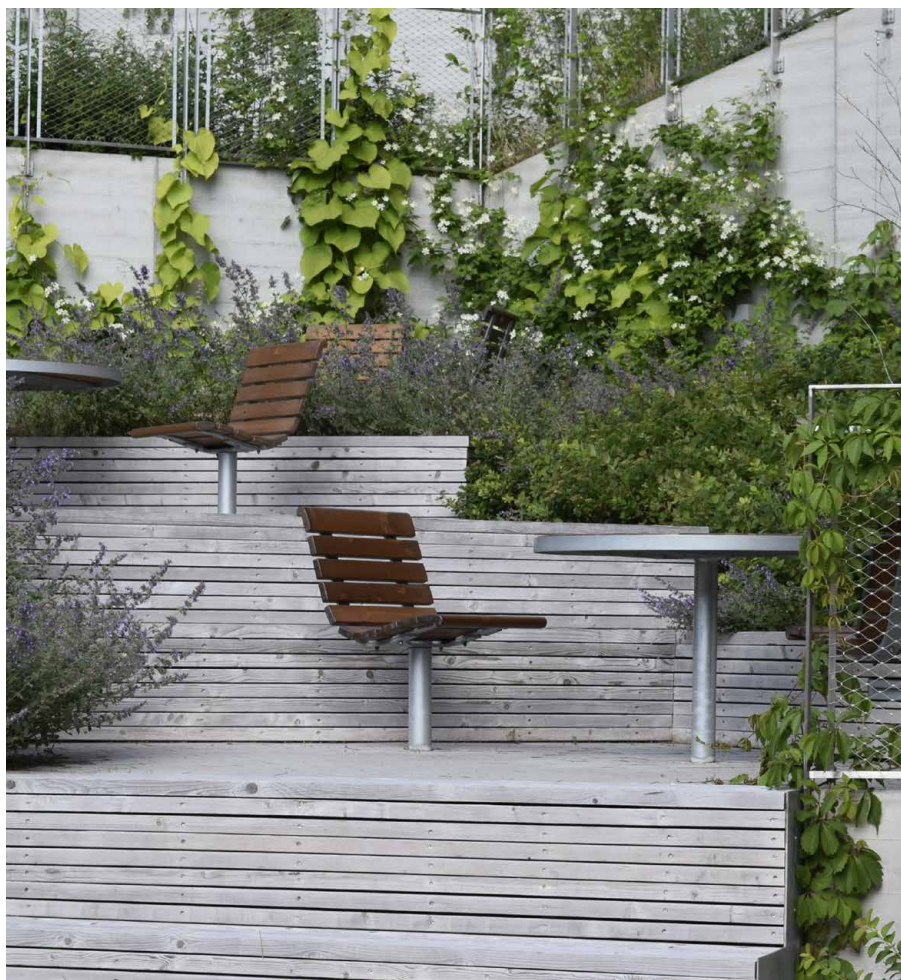

**Sofiero Bench Armrest**

8073770 *Black, 1 pair*  
8073771 *Galvanised, 1 pair*



**Sofiero Park Bench Armrest**

8037713 *Black, 1 pair*  
8037714 *Galvanised, 1 pair*



**Sofiero Bar Table** Nordic Pine

8077418 **CC** *Dark Brown/Black*  
8077436 **OM** *Dark Brown/Black*  
8077425 **CC** *Dark Brown/Galvanised*  
8077439 **OM** *Dark Brown/Galvanised*  
☛ 0,6 x 0,6 x 1,1



**Sofiero Bar Stool** Nordic Pine

8077427 **CC** *Dark Brown/Black*  
8077444 **OM** *Dark Brown/Black*  
8077431 **CC** *Dark Brown/Galvanised*  
8077445 **OM** *Dark Brown/Galvanised*  
☛ 0,55 x 0,4 x 0,75



**Sofiero Bar Collection** Nordic Pine

8077450 **CC** *Dark Brown/Black*  
8077452 **OM** *Dark Brown/Black*  
8077451 **CC** *Dark Brown/Galvanised*  
8077453 **OM** *Dark Brown/Galvanised*  
☛ 1,5 x 1,5 x 1,1



**Sofiero Bar Table** FSC Hardwood

8097647 **CC** *Brown/Black*  
8097649 **OM** *Brown/Black*  
8097646 **CC** *Brown/Galvanised*  
8097648 **OM** *Brown/Galvanised*  
☛ 0,6 x 0,6 x 1,1



**Sofiero Bar Stool** FSC Hardwood

8097655 **CC** *Brown/Black*  
8097653 **OM** *Brown/Black*  
8097650 **CC** *Brown/Galvanised*  
8097652 **OM** *Brown/Galvanised*  
☛ 0,55 x 0,4 x 0,75



**Sofiero Bar Collection** FSC Hardwood

8097651 **CC** *Brown/Black*  
8097657 **OM** *Brown/Black*  
8097654 **CC** *Brown/Galvanised*  
8097656 **OM** *Brown/Galvanised*  
☛ 1,5 x 1,5 x 1,1

Sofiero



**Sofiero Smart Stool Ø 800 - 45°** Nordic Pine

- 8073688 **CC** Dark Brown/Black
- 8074137 **OM** Dark Brown/Black
- 8073166 **CC** Dark Brown/Galvanised
- 8074136 **OM** Dark Brown/Galvanised
- ☛ 0,5 x 0,35 x 0,45



**Bench Sofiero Smart Ø 800 - 90°** Nordic Pine

- 8073700 **CC** Dark Brown/Black
- 8074142 **OM** Dark Brown/Black
- 8073169 **CC** Dark Brown/Galvanised
- 8074140 **OM** Dark Brown/Galvanised
- ☛ 0,75 x 0,75 x 0,45



**Sofiero Smart Stool Ø 1400 - 45°** Nordic Pine

- 8073748 **CC** Dark Brown/Black
- 8074174 **OM** Dark Brown/Black
- 8073747 **CC** Dark Brown/Galvanised
- 8074171 **OM** Dark Brown/Galvanised
- ☛ 0,75 x 0,55 x 0,45



**Stool Sofiero Smart Ø 800 - 45°** FSC Hardwood

- 8097622 **CC** Brown/Black
- 8097624 **OM** Brown/Black
- 8097621 **CC** Brown/Galvanised
- 8097623 **OM** Brown/Galvanised
- ☛ 0,5 x 0,35 x 0,45



**Bench Sofiero Smart Ø 800 - 90°** FSC Hardwood

- 8097626 **CC** Brown/Black
- 8097628 **OM** Brown/Black
- 8097625 **CC** Brown/Galvanised
- 8097627 **OM** Brown/Galvanised
- ☛ 0,75 x 0,75 x 0,45



**Sofiero Smart Stool Ø 1400 - 45°** FSC Hardwood

- 8097635 **CC** Brown/Black
- 8097637 **OM** Brown/Black
- 8097634 **CC** Brown/Galvanised
- 8097636 **OM** Brown/Galvanised
- ☛ 0,75 x 0,55 x 0,45



**Sofiero Smart Bench Ø 1400 - 90°** Nordic Pine

- 8073760 **CC** Dark Brown/Black
- 8074183 **OM** Dark Brown/Black
- 8073759 **CC** Dark Brown/Galvanised
- 8074178 **OM** Dark Brown/Galvanised
- ☛ 1,05 x 1,05 x 0,45



**Sofiero Small Round Bench Ø 800/360°** Nordic Pine

- 8076395 **CC** Dark Brown/Black
- 8076398 **F** Dark Brown/Black
- 8076393 **CC** Dark Brown/Galvanised
- 8076396 **F** Dark Brown/Galvanised
- ☛ 1,5 x 1,5 x 0,45



**Sofiero Large Round Bench Ø 1400/360°** Nordic Pine

- 8076404 **CC** Dark Brown/Black
- 8076407 **F** Dark Brown/Black
- 8076401 **CC** Dark Brown/Galvanised
- 8076406 **F** Dark Brown/Galvanised
- ☛ 2,1 x 2,1 x 0,45



**Sofiero Smart Bench Ø 1400 - 90°** FSC Hardwood

- 8097639 **CC** Brown/Black
- 8097641 **OM** Brown/Black
- 8097638 **CC** Brown/Galvanised
- 8097640 **OM** Brown/Galvanised
- ☛ 1,05 x 1,05 x 0,45



**Sofiero Small Round Bench Ø 800/360°** FSC Hardwood

- 8097630 **CC** Brown/Black
- 8097633 **F** Brown/Black
- 8097629 **CC** Brown/Galvanised
- 8097632 **F** Brown/Galvanised
- ☛ 1,5 x 1,5 x 0,45

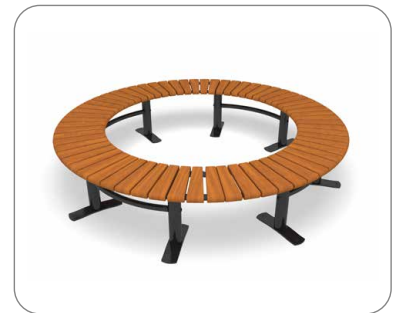

**Sofiero Large Round Bench Ø 800/360°** FSC Hardwood

- 8097643 **CC** Brown/Black
- 8097645 **F** Brown/Black
- 8097642 **CC** Brown/Galvanised
- 8097644 **F** Brown/Galvanised
- ☛ 2,1 x 2,1 x 0,45



## Sofiero Smart Connection types

Different connection sets are needed for the individual connection possibilities of the Sofiero modular benches. Choose the right screw set for the benches you want to combine.

### Inside curve (C-shape)

| Module 1 | Module 2 | Item no. Black | Item no. Galvanised |
|----------|----------|----------------|---------------------|
| 800 mm   | 800 mm   | 8073706        | 8073168             |
| 800 mm   | 1400 mm  | 8074265        | 8074264             |
| 1400 mm  | 1400 mm  | 8073758        | 8073757             |

### Outer Curve (S-shape)

| Module 1 | Module 2 | Item no. Black | Item no. Galvanised |
|----------|----------|----------------|---------------------|
| 800 mm   | 800 mm   | 8073721        | 8073720             |
| 800 mm   | 1400 mm  | 8074267        | 8074266             |
| 1400 mm  | 1400 mm  | 8074300        | 8074298             |

### Straight bench (J- or I-shape)

| Module 1       | Module 2       | Item no. Black | Item no. Galvanised |
|----------------|----------------|----------------|---------------------|
| Straight bench | 800 mm         | 8074284        | 8074268             |
| Straight bench | 1400 mm        | 8074297        | 8074292             |
| Straight bench | Straight bench | 8076503        | 8076502             |

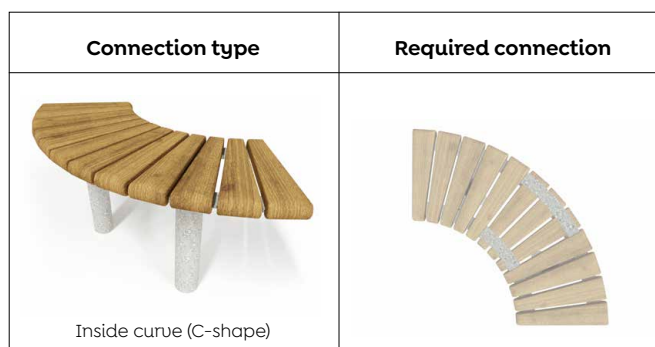



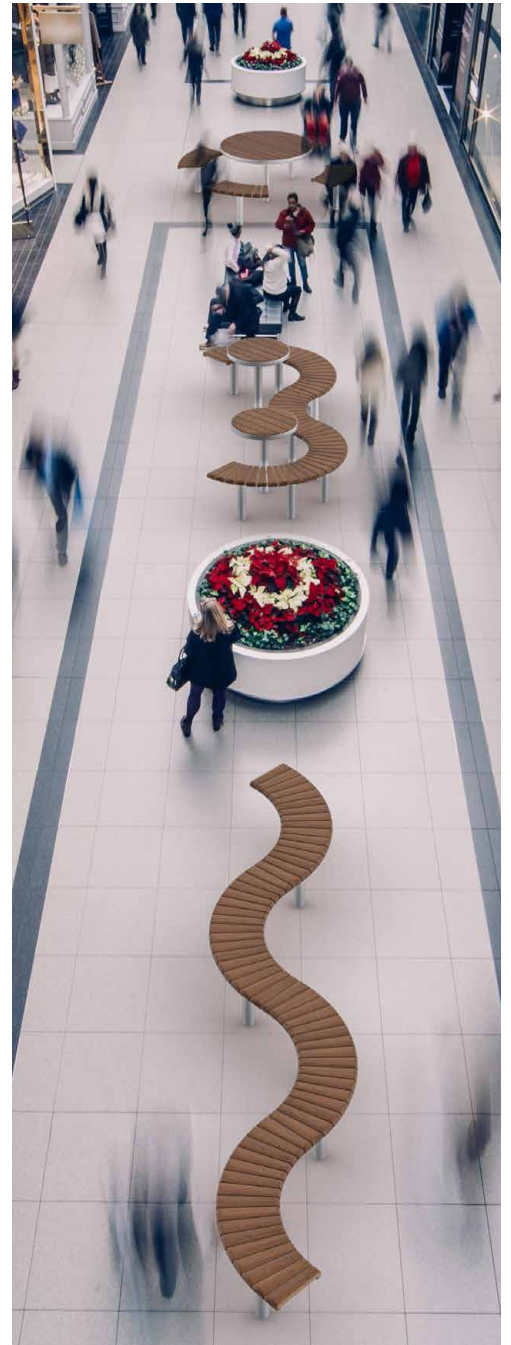



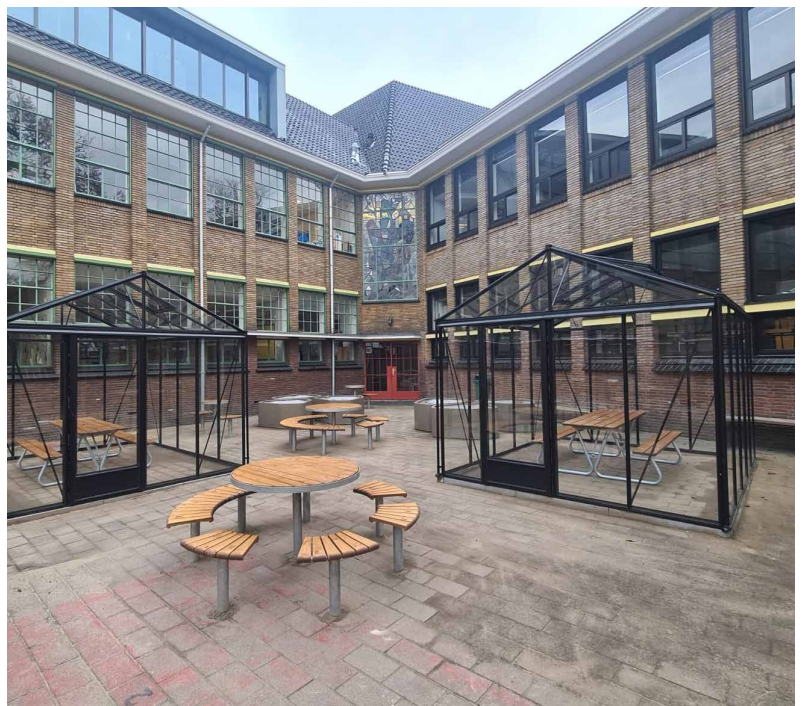









## EKEBY

The Ekeby series is simple but highly functional and has been carefully designed to last for many years. With its minimalist aesthetic, the series is the perfect complement to both urban and rural settings.

Available in pine, FSC hardwood, recycled plastic and HPL, the Ekeby range has a material suitable for every environment.

Armrests are also available and can be added for additional support if required.



### MATERIALS AND SURFACES

#### Main Material:

Slow-growing Nordic pine (FSC-certified), 45 x 93 mm and 45 x 120 mm.

Oiled, glazed and coated with matt lacquer.

Standard colour: Dark brown or green

Alternative materials: FSC hardwood, oiled, recycled plastic or HPL high-pressure laminate.

#### Frame:

Galvanised, lead-free primed and powder-coated or hot-dip galvanised square steel, 40 x 25 mm and 80 x 40 mm.

Standard colour: Black or Galvanised

Other colours available on request.

#### Anchoring Options

Freestanding/Above Ground

Cast in Place

Cast in Place with optional ground anchoring kit



# Ekeby



## Ekeby Bench Nordic Pine

8037104 **F** Dark Brown/Galvanised  
 8037103 **CC** Dark Brown/Galvanised  
 8037102 **F** Dark Brown/Black  
 8037101 **CC** Dark Brown/Black  
 ☛ 1,76 x 0,37 x 0,45



## Ekeby Park Bench Nordic Pine

8037007 **F** Dark Brown/Galvanised  
 8037013 **CC** Dark Brown/Galvanised  
 8037004 **F** Dark Brown/Black  
 8037002 **CC** Dark Brown/Black  
 ☛ 1,76 x 0,58 x 0,8



## Ekeby Table Nordic Pine

8037098 **F** Dark Brown/Galvanised  
 8037097 **CC** Dark Brown/Galvanised  
 8037029 **F** Dark Brown/Black  
 8037026 **CC** Dark Brown/Black  
 ☛ 1,3 x 0,66 x 0,71



## Bench Ekeby FSC Hardwood

8058445 **F** Brown/Galvanised  
 8058444 **CC** Brown/Galvanised  
 8058461 **F** Brown/Black  
 8058460 **CC** Brown/Black  
 ☛ 1,76 x 0,37 x 0,45



## Park bench Ekeby FSC Hardwood

8058442 **F** Brown/Galvanised  
 8058441 **CC** Brown/Galvanised  
 8058459 **F** Brown/Black  
 8058458 **CC** Brown/Black  
 ☛ 1,76 x 0,58 x 0,8



## Table Ekeby FSC Hardwood

8058447 **F** Brown/Galvanised  
 8058446 **CC** Brown/Galvanised  
 8058049 **F** Brown/Black  
 8058462 **CC** Brown/Black  
 ☛ 1,3 x 0,66 x 0,71



## Ekeby Bench Recycled Plastic

8064358 **F** Dark Brown/Galvanised  
 8064356 **CC** Dark Brown/Galvanised  
 8064355 **F** Dark Brown/Black  
 8064359 **CC** Dark Brown/Black  
 ☛ 1,76 x 0,37 x 0,45



## Ekeby Park Bench Recycled Plastic

8064306 **F** Dark Brown/Galvanised  
 8064354 **CC** Dark Brown/Galvanised  
 8064304 **F** Dark Brown/Black  
 8064352 **CC** Dark Brown/Black  
 ☛ 1,76 x 0,58 x 0,8



## Ekeby Table Recycled Plastic

8064365 **F** Dark Brown/Galvanised  
 8064369 **CC** Dark Brown/Galvanised  
 8064362 **F** Dark Brown/Black  
 8064366 **CC** Dark Brown/Black  
 ☛ 1,3 x 0,66 x 0,71



Also available in HPL

## Ekeby Park Bench Nordic Pine (Stackable)

8042424 **F** Dark Brown/Galvanised  
 8042447 **CC** Green/Black  
 ☛ 1,76 x 0,58 x 0,77



## Armrest Ekeby

8037715 *Black*, 1 pair  
 8037716 *Galvanised*, 1 pair



## Anchoring for Park Benches

8025744 **S** Galvanised, 1 pair  
 ☛ 0,94 x 0,62 x 0,25







# Ekeby



## Ekeby Bench HPL

8101204 **F** Green/Galvanised  
 8101178 **CC** Green/Galvanised  
 8101199 **F** Green/Black  
 8101175 **CC** Green/Black  
 ⚙️ 1,76 x 0,55 x 0,77



## Ekeby Bench HPL

8101205 **F** Grey/Galvanised  
 8101180 **CC** Grey/Galvanised  
 8101201 **F** Grey/Black  
 8101176 **CC** Grey/Black  
 ⚙️ 1,76 x 0,55 x 0,77

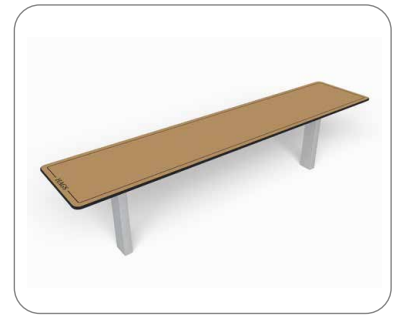

## Ekeby Bench HPL

8101207 **F** Beige/Galvanised  
 8101181 **CC** Beige/Galvanised  
 8101202 **F** Beige/Black  
 8101177 **CC** Beige/Black  
 ⚙️ 1,76 x 0,55 x 0,77



## Ekeby Park Bench HPL

8101287 **F** Green/Galvanised  
 8101268 **CC** Green/Galvanised  
 8101284 **F** Green/Black  
 8101265 **CC** Green/Black  
 ⚙️ 1,76 x 0,59 x 0,77



## Ekeby Park Bench HPL

8101288 **F** Grey/Galvanised  
 8101269 **CC** Grey/Galvanised  
 8101285 **F** Grey/Black  
 8101266 **CC** Grey/Black  
 ⚙️ 1,76 x 0,59 x 0,77



## Ekeby Park Bench HPL

8101289 **F** Beige/Galvanised  
 8101271 **CC** Beige/Galvanised  
 8101286 **F** Beige/Black  
 8101267 **CC** Beige/Black  
 ⚙️ 1,76 x 0,59 x 0,77



## Ekeby Table HPL

8101165 **F** Green/Galvanised  
 8101157 **CC** Green/Galvanised  
 8101162 **F** Green/Black  
 8101144 **CC** Green/Black  
 ⚙️ 1,33 x 0,62 x 0,70



## Ekeby Table HPL

8101171 **F** Grey/Galvanised  
 8101158 **CC** Grey/Galvanised  
 8101163 **F** Grey/Black  
 8101147 **CC** Grey/Black  
 ⚙️ 1,33 x 0,62 x 0,70



## Ekeby Table HPL

8101174 **F** Beige/Galvanised  
 8101159 **CC** Beige/Galvanised  
 8101164 **F** Beige/Black  
 8101154 **CC** Beige/Black  
 ⚙️ 1,33 x 0,62 x 0,70



## Ekeby Wall Top

8098582 *Dark Brown*  
 ⚙️ 1,76 x 0,4 x 0,06



## Ekeby Bench - wall-mounted

8098806 *Dark Brown/Galvanised*  
 8098581 *Dark Brown/Black*  
 ⚙️ 1,76 x 0,45 x 0,38











# ZETA

Zeta, a small yet highly appreciated furniture group that seamlessly complements schoolyards, rest areas, and unique urban settings. This series combines robust flat iron with beautiful wooden surfaces, creating a captivating blend of strength and character.

The sofa's base, armrests, and backrest harmoniously align, creating an alluring sense of light and space that runs consistently throughout the entire collection. Ergonomics have been meticulously attended to, ensuring exceptional comfort and enhanced mobility, even for the elderly.

The versatile Zeta series comprises a sofa, table, standing bench, and standing table. Additionally, it features bicycle bollards that offer a comprehensive and uniform outdoor environment.

**Designer:** Gustav Hallén



**Zeta Bar Table**

8037072 Silver Grey/Galvanised

⌀ 1,5 x 0,32 x 1



**Zeta Park Bench**

8037075 Silver Grey/Galvanised

⌀ 1,5 x 0,54 x 0,8



**Zeta Table**

8037074 Silver Grey/Galvanised

⌀ 1,2 x 0,7 x 0,75



**Zeta Bar Bench (high)**

8037073 Silver Grey/Galvanised

⌀ 1,5 x 0,32 x 0,7

## MATERIALS AND SURFACES

### Main Material:

Slow-growing Nordic pine (FSC-certified), 45 x 45 mm and 45 x 67 mm.

Oiled, glazed and coated with matt lacquer.

Standard colour: Silver Grey

### Frame:

Hot-dip galvanised flat steel, 15 x 70 mm.

Standard colour: Galvanised

Other colours available on request.

### Anchoring Options

Cast in Place



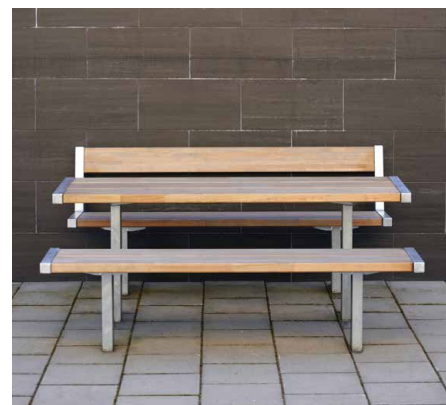

# PIXBO

Pixbo is made of robust and durable materials and features clean lines and a subtle colour palette.

The combination of excellent durability and timeless aesthetics makes it a suitable option for busy parks and urban environments.

Pixbo furniture is available in the standard colours: Black Brown and Silver Grey. Can also be lacquered in any other colour on request.

**Designer:** Gunilla Allard.



**Bench Pixbo**

- 8037094 **F** Black Brown/Galvanised
- 8037093 **CC** Black Brown/Galvanised

☛ 1,8 x 0,4 x 0,4



**Pixbo Park Bench** without armrest

- 8037079 **F** Black Brown/Galvanised
- 8037076 **CC** Black Brown/Galvanised
- 8037082 **F** Silver Grey/Galvanised
- 8037080 **CC** Silver Grey/Galvanised

☛ 1,77 x 0,54 x 0,79



**Pixbo Park Bench** with armrest

- 8037086 **F** Black Brown/Galvanised
- 8037085 **CC** Black Brown/Galvanised
- 8037088 **F** Silver Grey/Galvanised
- 8037087 **CC** Silver Grey/Galvanised

☛ 1,77 x 0,54 x 0,79



**Pixbo Table**

- 8037090 **F** Black Brown/Galvanised, 1,20 m
- 8037089 **CC** Black Brown/Galvanised, 1,20 m
- 8037092 **F** Black Brown/Galvanised, 1,80 m
- 8037091 **CC** Black Brown/Galvanised, 1,80 m

☛ 1,2/1,8 x 0,6 x 0,73



**Anchoring for Park Benches**

- 8025744 **S** Galvanised, 1 pair

☛ 0,94 x 0,62 x 0,25

MATERIALS AND SURFACES

**Main Material:**

Slow-growing Nordic pine (FSC-certified), 43 x 190 mm and 43 x 145 mm.

Oiled, glazed and coated with matt lacquer.

Standard colour: Black Brown or Silver Grey

**Frame:**

Square steel sides/foot section, 50 x 50 and 50 x 100 mm.

Standard colour: Galvanised

Other colours available on request.

**Anchoring Options**

Freestanding/Above Ground

Cast in Place

Cast in Place with optional ground anchoring kit





# RÖRKRÖKEN

As a classic HAGS product, the Rörkröken series invites you to stay and relax. The benches and tables can be combined to create a place for socialising that is tailored to any space and budget.

**Designer:** Gunnar Hallén



## Rörkröken Bench

8037019 Dark Brown/Black  
 8012634 Green/Black  
 8037023 Dark Brown/Galvanised  
 ⚙️ 1,5 x 0,4 x 0,45



## Rörkröken Park Bench

8037035 Dark Brown/Black  
 8012632 Green/Black  
 8037037 Dark Brown/Galvanised  
 ⚙️ 1,6 x 0,48 x 0,85



## Rörkröken Table

8037006 Dark Brown/Black  
 8012633 Green/Black  
 8037017 Dark Brown/Galvanised  
 ⚙️ 1,2 x 0,63 x 0,74

## MATERIALS AND SURFACES

### Main Material:

Slow-growing Nordic pine (FSC-certified), 45 x 45 mm and 45 x 165 mm.

Oiled, glazed and coated with matt lacquer.

Standard colour: Dark brown or green

### Frame:

Galvanised, lead-free primed and powder-coated or hot-dip galvanised steel tube, Ø 45 mm.

Standard colour: Black or Galvanised

Other colours available on request.

### Anchoring Options

Cast in Place





## CITY-FORM

Scandinavian design combined with simplicity and functionality.

With the products from our City-Form furniture series, you can easily put together your own individual furniture combinations according to your needs, wishes and surroundings.

The City-Form park bench boasts a gently curved shape and well-rounded ends, ensuring a comfortable seating experience. Its wooden slats not only provide a pleasant surface but also allow for effective water drainage and quick drying after rain showers.



### City-Form Bench

8037067 **CC** Dark Brown/Black  
8037187 **F** Dark Brown/Black  
☛ 1.88 x 0.6 x 0.45



### City-Form Park Bench

8042480 **CC** Dark Brown/Black  
8042482 **F** Dark Brown/Black  
☛ 1.88 x 0.64 x 0.82



### City-Form Table

8037065 **CC** Dark Brown/Black  
8042484 **F** Dark Brown/Black  
☛ 1.4 x 0.7 x 0.7

## MATERIALS AND SURFACES

### Main Material:

Slow-growing Nordic pine (FSC-certified), 45 x 45 mm and 45 x 77 mm.

Oiled, glazed and coated with matt lacquer.

Standard colour: Dark Brown

### Frame:

Galvanised, lead-free primed and powder-coated flat steel and steel tube, Ø 89 mm.

Standard colour: Black

Other colours available on request.

### Anchoring Options

Freestanding/Above Ground

Cast in Place





# BIRKA

Birka, a contemporary and remarkably stylish furniture series, effortlessly combines modern and classic aesthetics with its clear and simple design.

The series features a versatile bench and a freestanding table, offering flexibility for various arrangements through optional connecting plates.

Whether you desire different corners or a linear configuration, Birka adapts to your preferences. Additionally, the optional armrest enhances the user experience by providing excellent support when transitioning from a moment of relaxation to standing up.

**Designer:** Jan Wickelgren



### Birka Bench

- 8003213 **F** Teak Red/Galvanised
- 8003218 **F** Brown (FSC Hardwood)/Galvanised
- 8037083 **F** Silver Grey/Galvanised

☞ 1,76 x 0,49 x 0,45



### Birka Table

- 8003221 **F** Teak Red/Galvanised
- 8003224 **F** Brown (FSC Hardwood)/Galvanised
- 8037084 **F** Silver Grey/Galvanised

☞ 1,76 x 0,49 x 0,72

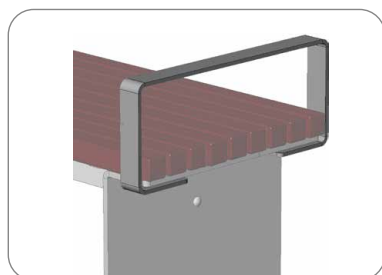

### Birka Armrest Galvanised

8020359 1 pair

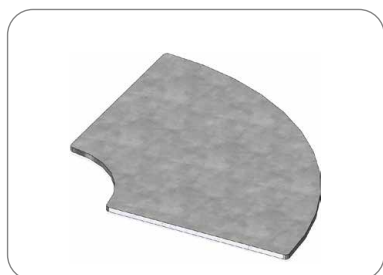

### Birka Connecting Plate Galvanised

- 8003226 90° Arch
- 8003233 Straight
- 8020348 Triangle
- 8020399 Triangle with drill hole

## MATERIALS AND SURFACES

### Main Material:

Slow-growing Nordic pine (FSC-certified), 45 x 45 mm.  
 Oiled, glazed and coated with matt lacquer.  
 Standard Colours: Teak Red or Silver Grey  
 Alternative materials: FSC hardwood, oiled, brown

### Frame:

Hot-dip galvanised flat steel, 12 mm.  
 Standard colour: Galvanised  
 Other colours available on request.

### Anchoring Options

Freestanding/Above Ground







## GRID

With its striped pattern and smooth surface, the Grid series makes a bold design statement and adds the finishing touch to a modern space.

Grid benches are suitable for both indoor and outdoor use and can be combined to create a unique seating combination to suit your budget or space.

The playful, flexible design allows architects and designers to achieve different looks and enhance urban squares, shopping centres or commercial spaces. The steel and HPL slats make the benches a durable and low-maintenance solution.

**Designer:** Lars Vejen



### Grid Bench

8029282 **S** Dark Brown/Grey

8029283 **CC** Dark Brown/Grey

8031987 **F** Dark Brown/Grey

⌀ 1,8 x 0,6 x 0,45

### MATERIALS AND SURFACES

#### Main Material:

HPL high pressure laminate,  
9 x 55 mm.

Standard colour: Dark Brown

#### Frame:

Galvanised, lead-free primed and powder-coated  
Steel tube, Ø 89 mm and flat steel, 8 mm.

Standard colour: Grey

Other colours available on request.

#### Anchoring Options

Freestanding/Above  
Ground

Cast in Place

Sunken Foundation



# BRAHE

In many places, solid park furniture is needed and a concrete foundation can be the solution.

With its rustic and timeless design, this robust and comfortable park furniture series blends in with its surroundings. Brahe consists of a table, a park bench and a bench and is equally suitable for a park or a schoolyard.



### Brahe Bench

8042477 **S** Dark Brown/White

☛ 1,76 x 0,38 x 0,45



### Brahe Park Bench

8042472 **S** Dark Brown/White

☛ 1,76 x 0,65 x 0,8



### Brahe Table

8042476 **S** Dark Brown/White

☛ 1,3 x 0,66 x 0,7

## MATERIALS AND SURFACES

### Main Material:

Slow-growing Nordic pine (FSC certified), 45 x 93 mm, 45 x 120 mm and 45 x 190 mm.

Oiled, glazed and coated with matt lacquer.

Standard colour: Dark Brown

### Frame:

Concrete.

Standard colour: White

Other colours available on request.

### Anchoring Options

Sunken Foundation





# STJERNEBORG

The Stjerneborg furniture series, consists of a park bench, a bench and a table, and is robust and weather-resistant. It is therefore particularly suitable for coastal areas or next to lakes and rivers.

Due to its solid concrete foundation, the bench can simply be placed freestanding.



### Stjerneborg Bench

8042466 **F** Dark Brown/Galvanised/White

☛ 1,76 x 0,52 x 0,45



### Stjerneborg Park Bench

8042441 **F** Dark Brown/Galvanised/White

☛ 1,76 x 0,55 x 0,75



### Stjerneborg Table

8042462 **F** Dark Brown/Galvanised/White

☛ 1,3 x 0,66 x 0,6

## MATERIALS AND SURFACES

### Main Material:

Slow-growing Nordic pine (FSC-certified), 45 x 93 mm and 45 x 120 mm.

Oiled, glazed and coated with matt lacquer.

Standard colour: Dark Brown

### Frame:

Hot-dip galvanised steel and concrete.

Standard colour: Galvanised/White

Other colours available on request.

### Anchoring Options

Freestanding

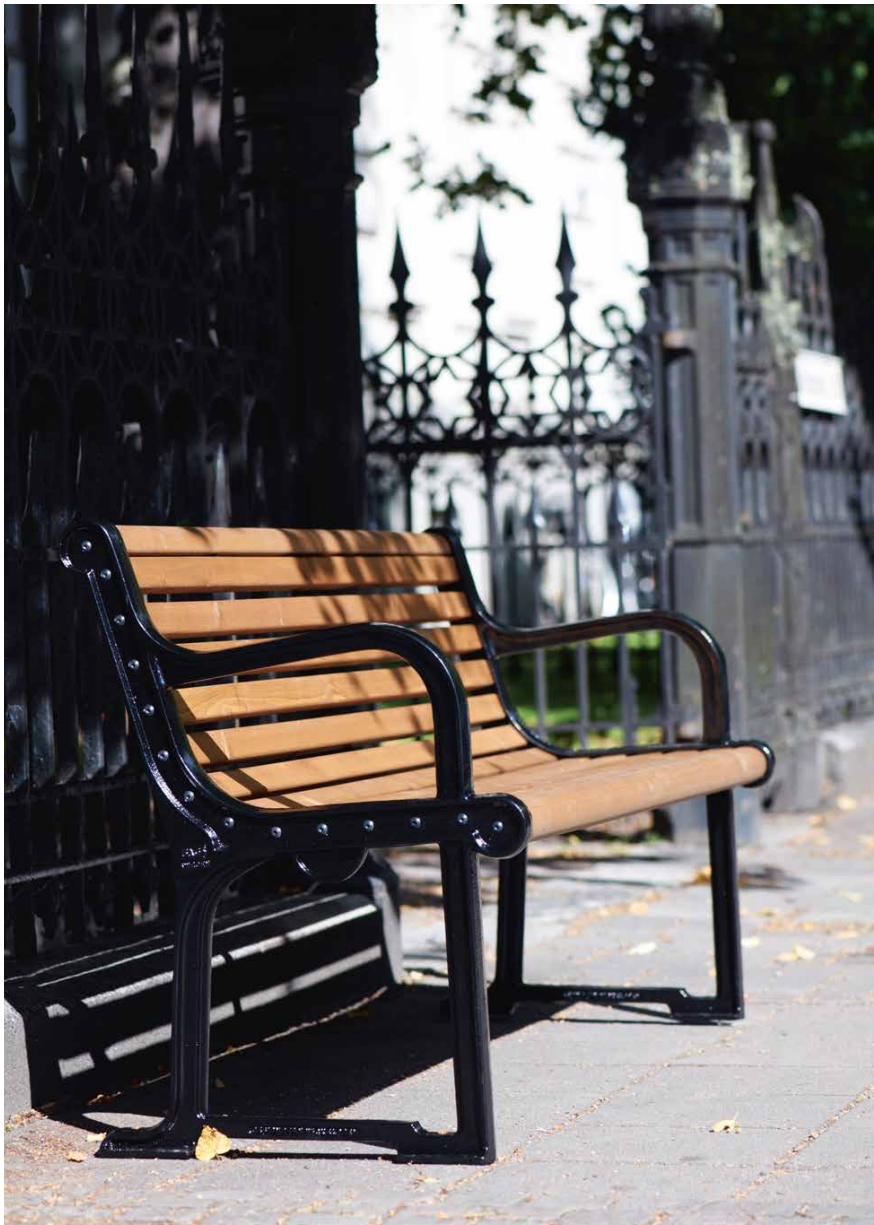

# GRIPSHOLM

Gripsholm is a classic and stylish furniture series that fits particularly well in historical settings. Its cast iron frame also fits perfectly into modern urban spaces. Gripsholm gives a feeling of traditional craftsmanship, with its high quality materials and design, ensuring that it will age perfectly with its surroundings. It is designed to accommodate users of different ages and abilities very comfortably.

**Designer:** Jan Wickelgren



**Gripsholm Bench**

8037162 **F** Dark Brown/Black  
 ⚙️ 1,89 x 0,56 x 0,47



**Gripsholm Park Bench**

8037041 **F** Dark Brown/Black  
 ⚙️ 1,9 x 0,62 x 0,85



**Gripsholm Table**

8037163 **F** Dark Brown/Black  
 ⚙️ 1,43 x 0,71 x 0,71

MATERIALS AND SURFACES

**Main Material:**

Slow-growing Nordic pine (FSC-certified), 33 x 45 mm.  
 Oiled, glazed and coated with matt lacquer.  
 Standard colour: Dark Brown

**Frame:**

Powder-coated Cast Iron.  
 Standard colour: Black  
 Other colours available on request.

**Anchoring Options**

Freestanding/Above Ground





# ENGLAND

The England furniture series represents HAGS' interpretation of the classic English-style wooden bench. Constructed entirely from solid wood, this series exudes a traditional and robust appearance. The bench and armchair feature elegantly curved armrests, as well as contoured seat and backrests, ensuring optimal comfort. With a slightly raised seat height and sturdy armrests, sitting down and getting up become effortless tasks.

**Designer:** Jan Wickelgren

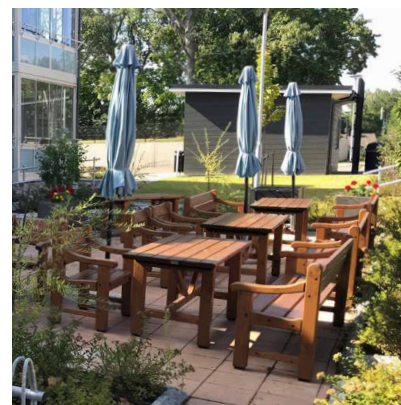

**England Park Bench**

8037811 **F** Dark Brown  
 ⌀ 1,8 x 0,63 x 0,85



**England Armchair**

8037812 **F** Dark Brown  
 ⌀ 0,7 x 0,63 x 0,85



**England Table**

8037045 **F** Dark Brown  
 ⌀ 1,4 x 0,76 x 0,75

## MATERIALS AND SURFACES

### Main Material:

Slow-growing Nordic pine (FSC-certified), 45 x 143 mm and 68 x 93 mm.

Oiled, glazed and coated with matt lacquer.

Standard colour: Dark Brown

Other colours available on request.

### Anchoring Options

Freestanding







**Spin Bench** (95 cm wide)  
 8039588 **CC** Dark Brown/Grey - fixed  
 8039780 **CC** Dark Brown/Grey - rotatable  
 8039568 **CC** Dark Brown/Galvanized - fixed  
 8039781 **CC** Dark Brown/Galvanized - rotatable  
 ⌀ 1,16 x 0,58 x 0,9



**Stockholm Park Bench** Stackable  
 8037128 **F** Dark Brown/Galvanized  
 8027178 **F** Green/Galvanized  
 ⌀ 2,1 x 0,8 x 0,8

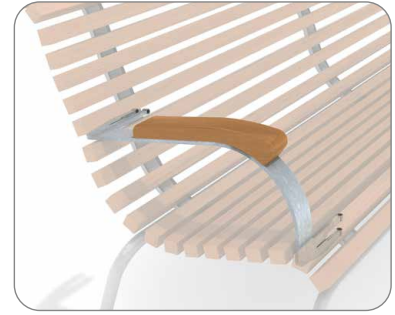

**Stockholm Armrest**  
 8037711 Dark Brown/Galvanized, 1 pair  
 8037818 Green/Galvanized, 1 pair



**Taberg Park Bench**  
 8037061 **F** Dark Brown/Black  
 ⌀ 1,86 x 0,5 x 0,8



**Djurgården Park Bench**  
 8037005 **CC** Dark Brown/Galvanized  
 8012671 **CC** Green/Galvanized  
 ⌀ 1,76 x 0,6 x 0,85



**Djurgården/Gripenberg Armrest**  
 8037710 Dark Brown/Galvanized, 1 pair  
 8012673 Green/Galvanized, 1 pair



**Gripenberg Park Bench**  
 8003192 **CC** Dark Brown/Galvanized  
 ⌀ 1,76 x 0,5 x 0,8



**Riddersberg Park Bench**  
 8042488 **F** Dark Brown Concrete base  
 ⌀ 1,76 x 0,6 x 0,82



**Esplanad Park Bench Steel**  
 8003211 **CC** Silver  
 8003205 **F** Silver  
 ⌀ 1,86 x 0,65 x 0,83



**Rox Bench**  
 8034939 **F** Silver Grey/Galvanized  
 8034938 **F** Silver Grey/Black  
 8035029 **F** Brown/Black  
 ⌀ 1,5 x 0,52 x 0,45







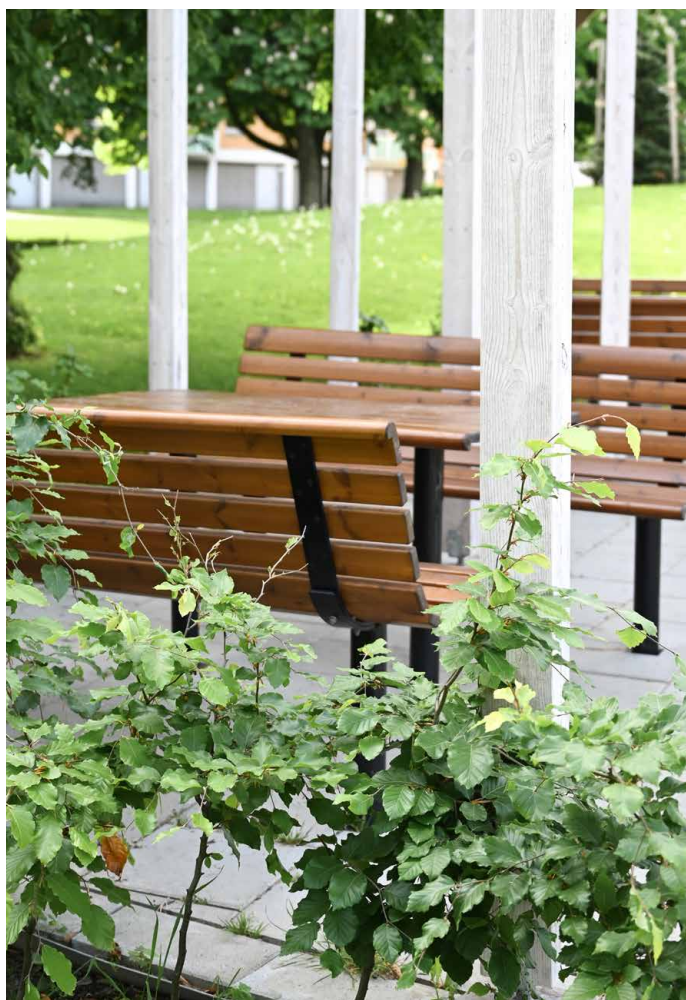
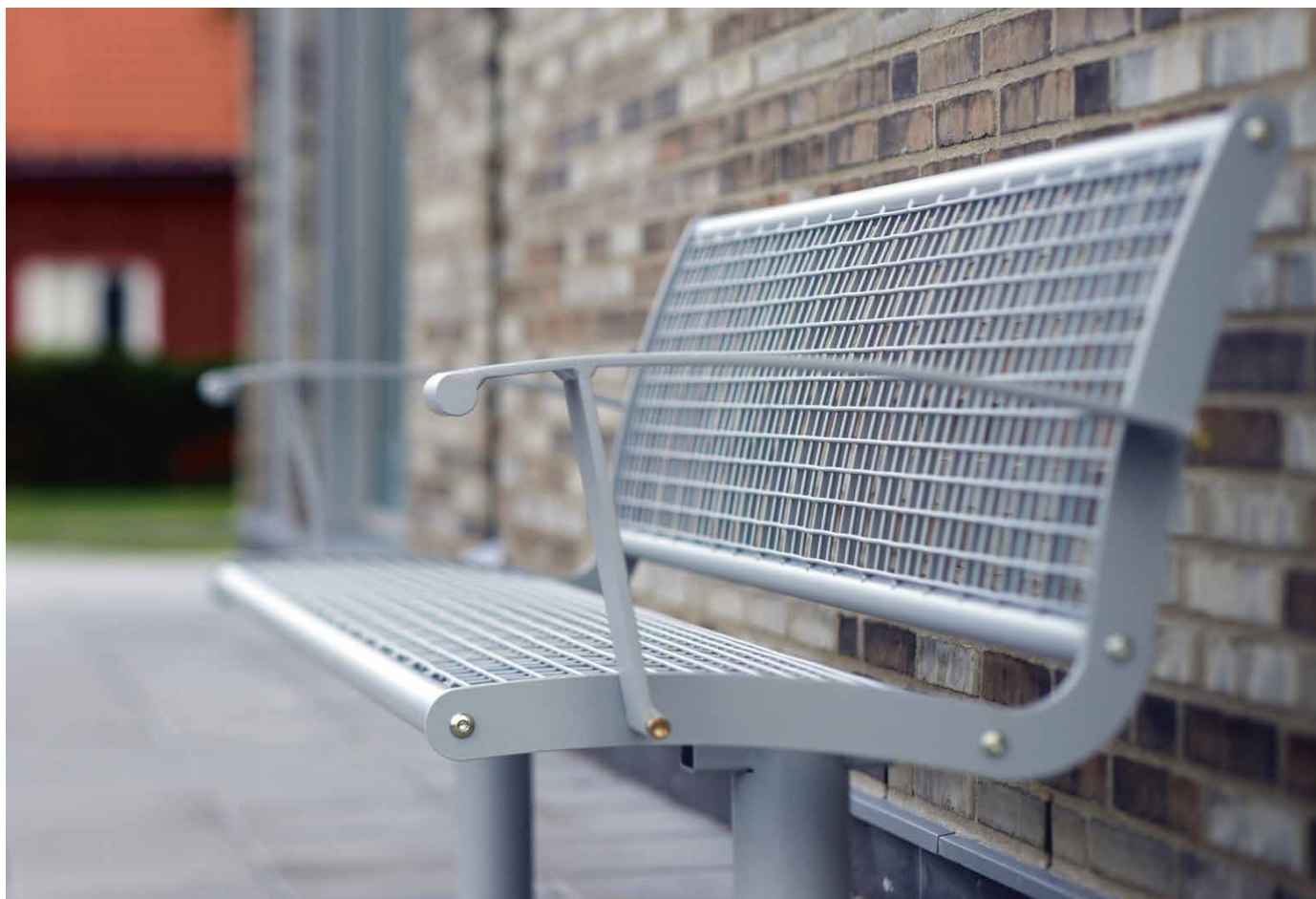





# PICNIC TABLES





Our picnic tables invite you to spend time together outdoors.

With a wide variety of lengths and seat heights, in materials from wood to HPL, to recycled plastic and inclusive solutions for wheelchairs - you're sure to find the right product for your needs in this extensive selection.



Picnic Tables



**Hallon** Nordic Pine, seat height 35 cm  
 8042474 **F** Dark Brown/Galvanised, L 1.80  
 8059770 **F** Dark Brown/Galvanised, L 2.20  
 8042475 **F** Dark Brown/Galvanised, L 2.90  
 ⌀ 1,8/2,2/2,9 x 1,3 x 0,6



**Hallon** Recycled plastic, seat height 35 cm  
 8064457 **F** Dark Brown/Galvanised, L 1.80  
 ⌀ 1,8 x 1,3 x 0,61



**Gullviva** Nordic Pine, seat height 45 cm  
 8042461 **F** Dark Brown/Galvanised  
 8042470 **F** Dark Brown/Black  
 ⌀ 2,9 x 1,5 x 0,72



**Linnea** Nordic Pine, seat height 45 cm  
 8040355 **F** Dark Brown/Galvanised  
 8042471 **F** Dark Brown/Black  
 ⌀ 1,8 x 1,5 x 0,72



**Linnea** Recycled Plastic, seat height 45 cm  
 8064455 **F** Dark Brown/Galvanised  
 8064456 **F** Dark Brown/Black  
 ⌀ 1,8 x 1,55 x 0,73



**Linnea** HPL, seat height 45 cm  
 8101055 **F** Green/Galvanised  
 8101056 **F** Grey/Galvanised  
 8101057 **F** Beige/Galvanised  
 ⌀ 1,76 x 1,72 x 0,73



**Ljung** Nordic Pine, seat height 45 cm, with backrest  
 8040358 **F** Dark Brown/Galvanised  
 ⌀ 1,8 x 1,76 x 0,72



**Olvon** Nordic Pine, seat height 45 cm, wheelchair accessible  
 8042460 **F** Dark Brown/Galvanised  
 ⌀ 2,2 x 1,6 x 0,72

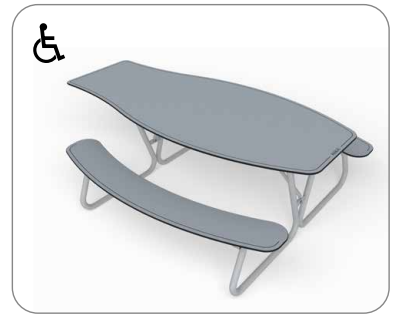

**Olvon** HPL, seat height 45 cm  
 8101369 **F** Green/Galvanised  
 8101375 **F** Grey/Galvanised  
 8101378 **F** Beige/Galvanised  
 ⌀ 2,16 x 1,73 x 0,73



Also available with 7 seats (wheelchair accessible)

**Skagen** HPL, 8 seats, seat height 45 cm  
 8100861 **F** Green/Galvanised  
 8100868 **F** Grey/Galvanised  
 8100870 **F** Beige/Galvanised  
 ⌀ 1,75 x 1,75 x 0,77



**Skagen** Nordic Pine, seat height 45 cm  
 8042483 **F** Dark Brown/Galvanised 7 seats (wheelchair accessible)  
 8042481 **F** Dark Brown/Galvanised 8 seats  
 ⌀ 1,37 x 1,75 x 0,73







**Allround** HPL  
 8061734 **F** Light Grey/Galvanised  
 ⌀1,25 x 1,95 x 0,72



**Träjon** Nordic Pine  
 8040189 **F** Dark Brown, L 1,76  
 8042485 **F** Dark Brown, L 2,91  
 ⌀1,76/2,91 x 1,48 x 0,73





# GRILLS & PLANTERS











**Chili Grill**  
8019466 **F** Black  
☉ 0,85 x 0,78 x 0,8



**Pepper Grill**  
8072859 **F** Black  
☉ 10,85 x 0,45 x 0,8

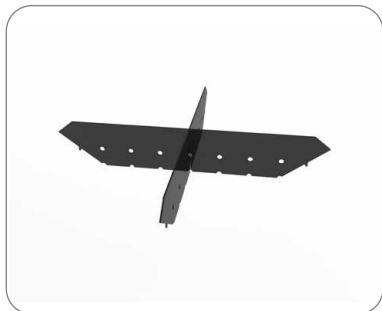

**Division for Chili Grill**  
8072871 Black



**Mounting plate/lid**  
8091125 Black, 1 piece for Pepper Grill  
8091130 Black, 2 pieces for Chili Grill



MATERIALS AND SURFACES

**Frame:**

Galvanised, lead-free primed and powder-coated sheet steel, 3 mm. Suitable for extra high temperatures.

Standard colour: Black

Other colours available on request. available.

**Anchoring Options**

Freestanding  
(can also be installed with sunken foundations or cast in place if required)





**Flox Flowerpot, Low** 0.60 m

8034853 **F** Black

8034855 **F** Galvanised

8034919 Irrigation Tank

☉ 0.78 x 0.78 x 0.60



**Flox Flowerpot, High** 0.72 m

8034852 **F** Galvanised

8034851 **F** Black

8034919 Irrigation Tank

☉ 0.78 x 0.78 x 0.72



MATERIALS AND SURFACES

**Frame:**

Galvanised, lead-free primed and powder-coated or hot-dip galvanised sheet steel, 3 mm.

Standard colour: Black or Galvanised

Other colours available on request.  
available.

**Anchoring Options**

Freestanding  
(can also be installed with sunken foundations or cast in place if required)



# LITTER BINS





# & ASHTRAYS

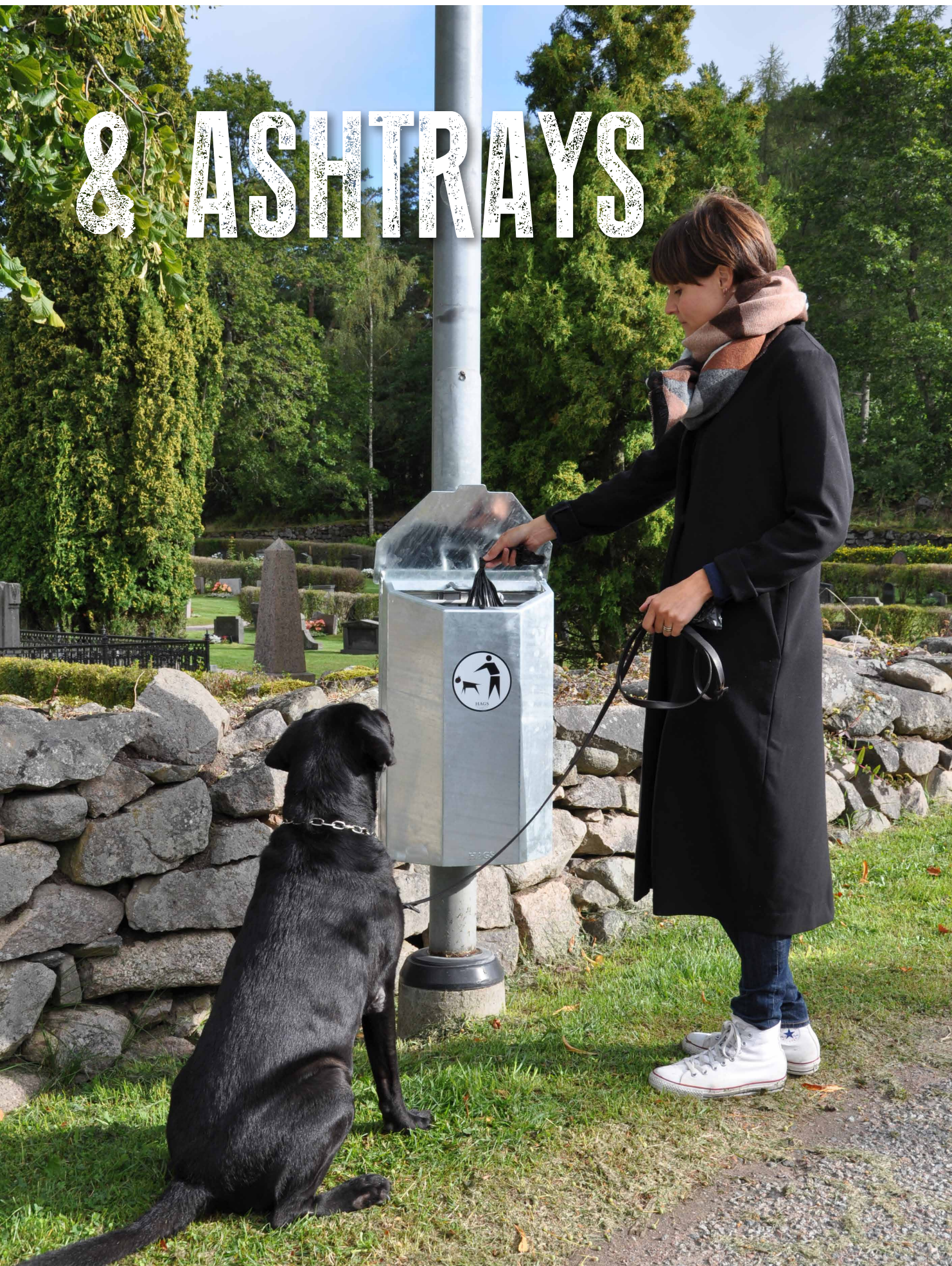



## Bins & Ashtrays



**Ellipse Litter Bin** Black 60 L

8000136 **S** | 8000137 60 mm Post mount  
 8000134 **CC** | 8000138 108 mm post mount  
 8000135 **F** | 8000139 For wall mounting  
 ⚙️ 0,5 x 0,4 x 1,



**Nora Litter Bin** Galvanised 70 L

8036662 **S**  
 8037204 **F**  
 ⚙️ 0,4 x 0,4 x 1,05



**Nora Litter Bin** Black 70 L

8037205 **S**  
 8037206 **F**  
 8037208 **F** With ashtray  
 8037207 **S** With ashtray  
 ⚙️ 0,4 x 0,4 x 1,05



**Oxel Litter Bin** Galvanised 25 L

8000116 **CC** with side posts  
 8000117 For wall/post mounting  
 ⚙️ 0,27 x 0,27 x 0,75



**Rosen Litter Bin** Galvanised 40 L

8059336 **F** With stand  
 8049776 For wall/post mounting  
 8051304 Stop Bracket  
 ⚙️ 0,29 x 0,4 x 0,63



**Rosen Litter Bin** Black 40 L

8059337 **F** With stand  
 8049774 For wall/post mounting  
 8051304 Stop Bracket  
 ⚙️ 0,29 x 0,4 x 0,63



**Poppel Litter Bin** Red 25 L

8000122 **CC** With side post  
 8000128 **CC** With ground anchoring  
 8000131 **F** With stand  
 8000125 For wall/post mounting  
 ⚙️ 0,39 x 0,28 x 0,75



**Poppel Litter Bin** Green 25 L

8000123 **CC** With side post  
 8000129 **CC** With ground anchoring  
 8000132 **F** With stand  
 8000126 For wall/post mounting  
 ⚙️ 0,39 x 0,28 x 0,75



**Poppel Litter Bin** Black 25 L

8000124 **CC** With side post  
 8000130 **CC** With ground anchoring  
 8000133 **F** With stand  
 8000127 For wall/post mounting  
 ⚙️ 0,39 x 0,28 x 0,75



**Poppel/Asken Litter Bin** Black 25 L

8000114 **F** With stand  
 8000112 **CC** With ground anchoring  
 ⚙️ 0,56 x 0,29 x 0,78



**Sergel Litter Bin** 140 L

8000109 **F** Black  
 8000111 **F** Galvanised  
 8000103 **S** Black  
 8000107 **S** Galvanised  
 ⚙️ 0,7 x 0,7 x 1,22



**Örebro Litter Bin** Black 25 L

8000118 **CC** With side post  
 8000120 **CC** With ground anchoring  
 8000121 **F** With stand  
 8000119 For wall/post mounting  
 ⚙️ 0,39 x 0,28 x 0,75





**Catfoot Litter Bin** Green 60 L  
8002753 For post mounting  
⌀ 0,53 x 0,3 x 0,75



**Asken Ashtray** with canopy  
8012745 *Stainless Steel* For wall mounting  
8012741 *Black* For wall mounting  
⌀ 0,18 x 0,16 x 0,43



**Asken Ashtray** without canopy  
8012743 *Stainless Steel* For wall mounting  
8012739 *Black* For wall mounting  
⌀ 0,18 x 0,16 x 0,29



**Gastro Ashtray** Black  
8012733 For wall mounting  
⌀ 0,18 x 0,12 x 0,3



**Fimpen Ashtray** Black  
8012713 **CC**  
8012712 **F**  
⌀ 1,13 x 0,34 x 1,13



**Smalviva Ashtray** Black  
8012716 **F** With grid  
8054638 **F** Without grid  
⌀ 0,32 x 0,32 x 0,64



**Reco Bin** for disposable barbecues  
8043891 **F** Galvanised Single  
8043892 **F** Galvanised Double

⌀ 0,7 x 0,7 x 1,3



**Anchoring for Litter Bins**  
8002748 **CC** ⌀ 33 mm - 0,5 m  
8002749 **CC** ⌀ 60 mm - 1,5 m



**Concrete foundation for litter bins**  
8002745 ⌀ 33 mm for Poppel/Örebro



**Litter bin label**  
8005389



**Label for dog waste bin**  
8005387





# BICYCLE STORAGE

Our bicycle stands and shelters are not only aesthetically pleasing with their elegant and modern design but also serve as the perfect solution for bicycle parking.

These structures provide an ideal spot for securely parking bicycles. With the integrated roof, the shelters offer effective protection from various weather conditions.

They can be seamlessly combined with our bicycle racks and effortlessly blend into any environment, thanks to their clean and sleek lines.

For enhanced security, an optional lockable gate is available, providing additional peace of mind.









HAGS bicycle shelters are available in various styles and colour combinations.



### Capella

Frame and wall elements made of hot-dip galvanized square steel.



#### Capella Bicycle Shelter

- 8043685 S Galvanized straight metal roof
  - 8043687 S Galvanized straight plastic roof
  - 8043684 S Galvanized curved metal roof
  - 8043686 S Galvanized curved plastic roof
- ☉ 4,3 x 2,6 x 2,3

#### Capella Bicycle Shelter Extension

- 8043830 S Galvanized straight metal roof
  - 8043832 S Galvanized straight plastic roof
  - 8043829 S Galvanized curved metal roof
  - 8043831 S Galvanized curved plastic roof
- ☉ 4,2 x 2,6 x 2,3



### Nova

Frame made of hot-dip galvanized square steel, wall elements made of hot-dip galvanized steel mesh.



#### Nova Bicycle Shelter

- 8043681 S Galvanized straight metal roof
  - 8043683 S Galvanized straight plastic roof
  - 8043680 S Galvanized curved metal roof
  - 8043682 S Galvanized curved plastic roof
- ☉ 4,3 x 2,6 x 2,3

#### Nova Bicycle Shelter Extension

- 8043824 S Galvanized straight metal roof
  - 8043826 S Galvanized straight plastic roof
  - 8043823 S Galvanized curved metal roof
  - 8043825 S Galvanized curved plastic roof
- ☉ 4,2 x 2,6 x 2,3



#### Nova Lockable Gate

- 8061917 Galvanized for straight roof
- 8064219 Galvanized for curved roof





## Stella

Frame made of hot-dip galvanised square steel. Wall elements made of knotless Nordic pine, painted with linseed oil-based black-brown wood stain.

Roofs made of corrugated sheet steel or transparent plastic, either straight or slightly curved.

In addition to the above-mentioned options, the steel components are available in a variety of other colours, and the wooden components of the Stella product variant can be manufactured in other glaze colours instead of black-brown.

Roofs can also be ordered from the factory with a preparatory surface for "green" roofs. Optional extensions allow any number of shelters to be placed end to end to create a combination tailored to your space and budget.



### Stella Bicycle Shelter

- 8043673 **S** Galvanised straight metal roof
  - 8043675 **S** Galvanised straight plastic roof
  - 8043672 **S** Galvanised curved metal roof
  - 8043674 **S** Galvanised curved plastic roof
- ☛ 4,3 x 2,6 x 2,3

### Stella Bicycle Shelter Extension

- 8043820 **S** Galvanised straight metal roof
  - 8043822 **S** Galvanised straight plastic roof
  - 8043819 **S** Galvanised curved metal roof
  - 8043821 **S** Galvanised curved plastic roof
- ☛ 4,2 x 2,6 x 2,3



### Stella Lockable Gate

- 8061911 *Black/Galvanised* for straight roof
- 8064211 *Black/Galvanised* for curved roof

### Accessories for Capella, Nova and Stella



### Crossbar with bicycle stand

- 8046277 *Galvanised* 5 spaces

### Bicycle Shelter Borås Galvanised

- 8012488 **CC** 6 spaces
  - 8012489 **CC** 12 spaces
  - 8012490 **CC** 18 spaces
  - 8012491 **CC** 24 spaces
  - 8012492 **CC** 30 spaces
- ☛ 2,1 x 2,4 x 2





## Modern solutions for staying sheltered outdoors with the Nova shelter

Whether as an outdoor classroom, a greenhouse or a waiting area, Nova's modules offer a flexible solution for a variety of applications.

- 100% modular
- Easily relocatable
- Highly durable construction made of galvanised steel
- Polycarbonate roof and side panels
- Ventilation gaps to maximize airflow
- Simple assembly through sunken foundation anchoring (no concrete necessary)

Contact us and we will help you plan the right solution for your project!











## BICYCLE RACKS

Our extensive range of bicycle racks ensures the safety of users while promoting proper bicycle storage.

The racks are available in a variety of shapes and designs, perfectly tailored to fit into any outdoor space.

Our range encompasses freestanding and modular designs that can be seamlessly combined with our selection of shelters.







**Gaspra Bicycle Stand**

8003519 **CC** Black/Galv. 4 spaces, adjustable  
 8003520 **CC** Black/Galv. 8 spaces, adjustable  
 8003521 **CC** Black 4 spaces, adjustable  
 8003522 **CC** Black 8 spaces, adjustable  
 ⚙️ 2 x 0,2 x 0,83

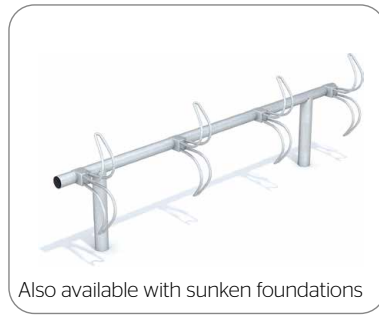

Also available with sunken foundations

**Optimal Bicycle Stand Galvanised**

8003497 **CC** 4 spaces single  
 8003501 **CC** 8 spaces single  
 8003499 **CC** 8 spaces double  
 8003503 **CC** 16 spaces double  
 ⚙️ 1,65 x 0,22 x 0,56



**Orion Bicycle Stand**

8003072 **CC** Black/Galvanised 4 spaces  
 8003074 **CC** Black/Galvanised 8 spaces  
 8003106 **CC** Black End posts  
 ⚙️ 2 x 0,24 x 0,9

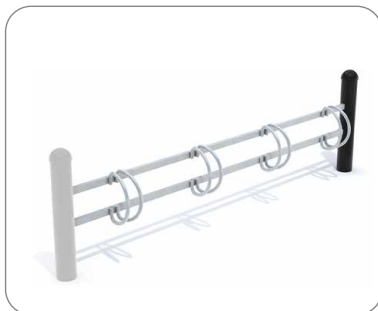

**Sirius Bicycle Stand**

8003073 **CC** Black/Galvanised 4 spaces  
 8003075 **CC** Black/Galvanised 8 spaces  
 8003080 **CC** Black End posts  
 ⚙️ 2 x 0,22 x 0,6



**Auriga Bicycle Stand**

8003510 **CC** Black 4 spaces, adjustable  
 8003524 **CC** Galvanised 4 spaces, adjustable  
 8003523 **CC** Galvanised 5 spaces, adjustable  
 ⚙️ 2 x 0,14 x 0,55

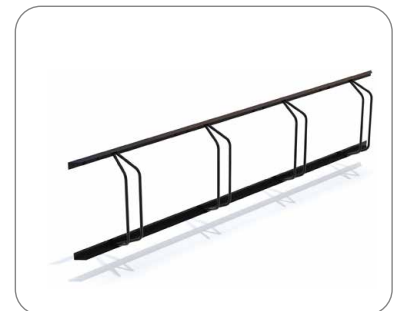

**Dorado Bicycle Stand**

8003514 **CC** Black 4 spaces, adjustable  
 8003530 **CC** Galvanised 4 spaces, adjustable  
 8003533 **CC** Galvanised 5 spaces, straight  
 ⚙️ 1,9 x 0,15 x 0,43



**Vela Bicycle Stand Galvanised**

8012596 **CC** 4 spaces  
 8012598 **CC** End posts  
 ⚙️ 2 x 0,2 x 0,47

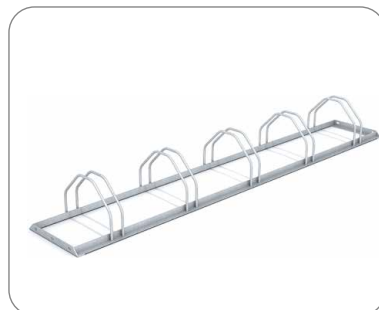

**Columba Bicycle Stand Galvanised**

8003535 **F** 5 spaces, straight  
 ⚙️ 2,14 x 0,36 x 0,25

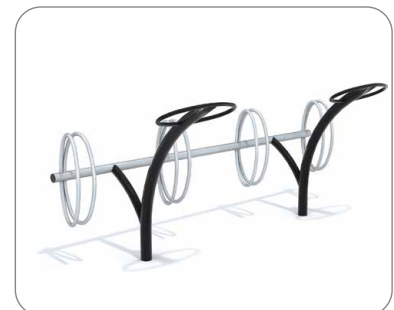

**Ellipse Bicycle Stand Galvanised/Black**

8003517 **CC** 4 spaces  
 ⚙️ 1,75 x 0,7 x 0,75



**Etta Bicycle Stand Galvanised**

8003531 **CC** 5 spaces, straight  
 ⚙️ 1,96 x 0,14 x 0,55

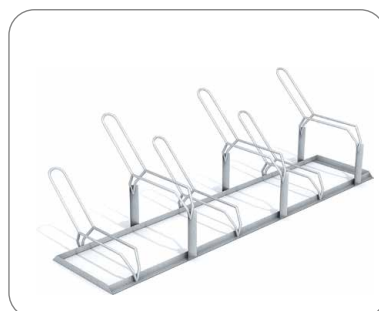

**Gemini Bicycle Stand Galvanised**

8003537 **F** 6 spaces, straight  
 ⚙️ 2 x 0,6 x 0,58



**Zeta Bicycle Stand Galvanised**

8012657 **CC** 4 spaces  
 8012661 **CC** End posts  
 ⚙️ 2,06 x 0,22 x 0,91



## Bicycle Racks & Shelters



**Zeta Bicycle Rack** Galvanised

8012654 **CC**

📏 0,1 x 0,06 x 0,91



**Sculptor Bicycle Bollard** Black

8003151 **CC**

📏 0,27 x 0,09 x 0,91



**Sagitta Bicycle Rack** Galvanised

8003148 **CC**

📏 0,05 x 0,32 x 0,9



**Rosenlund Bicycle Rack**

8079171 **CC** Red

8079172 **CC** Green

8079173 **CC** Blue

8079170 **CC** Dark Grey

8079169 **CC** Galvanised

📏 0,53 x 0,32 x 0,88 **CC**: Cast in Place



**Rosenlund Bicycle Rack**

8079166 **OM** Red

8079167 **OM** Green

8079168 **OM** Blue

8079165 **OM** Dark Grey

8079163 **OM** Galvanised

📏 0,53 x 0,32 x 0,88 **OM**: Above Ground





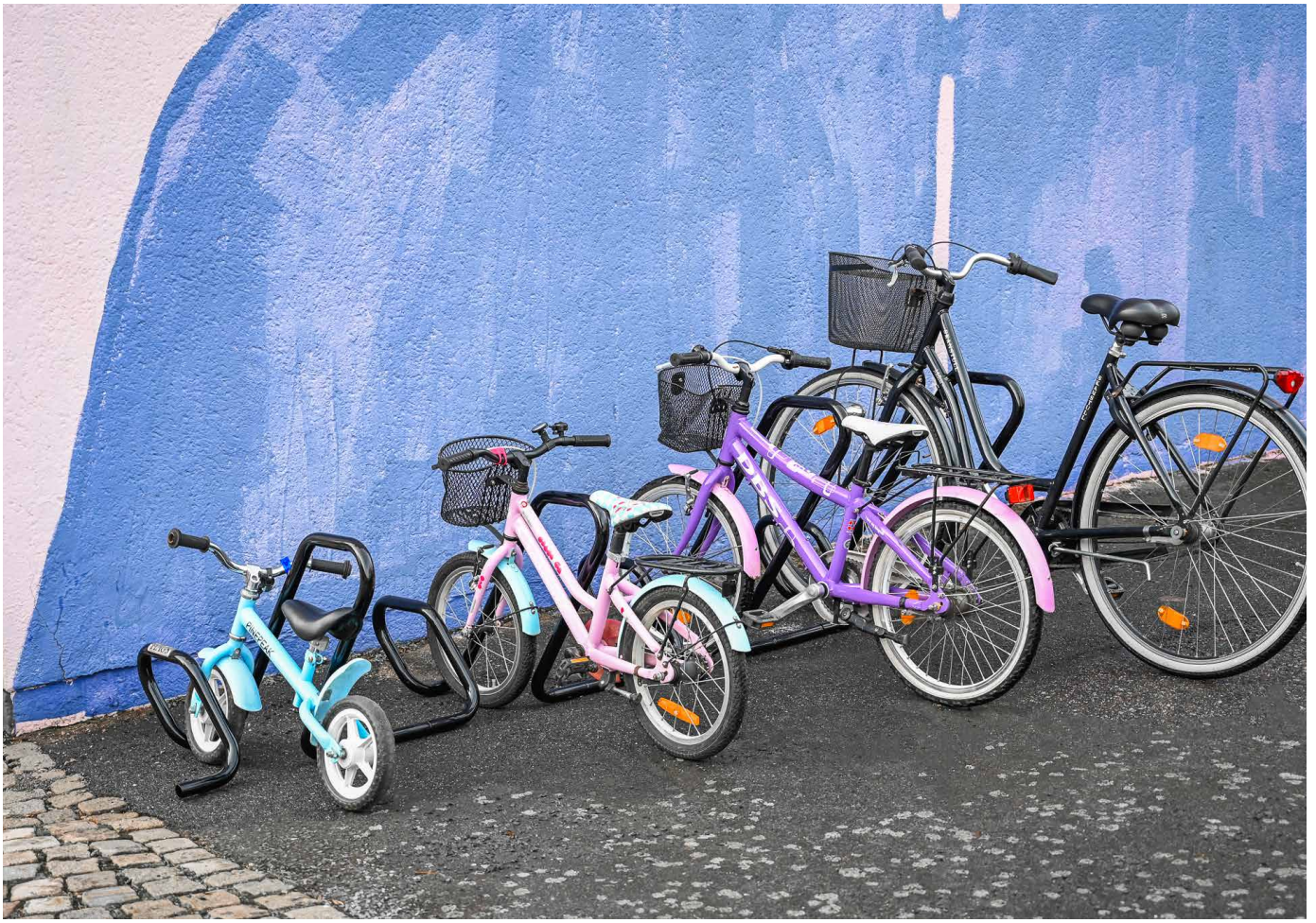

**Lyra Bicycle Stand (High)**

8090164 Black  
8090165 Grey

⌀ 0.5 x 0.81 x 0.7



**Lyra Bicycle Stand (Low)**

8090154 Black  
8090159 Grey

⌀ 0.5 x 0.7 x 0.54



**Lyra Bicycle Rack Extension (High)**

8090169 Black  
8090171 Grey

⌀ 0.7 x 0.81 x 0.7



**Lyra Bicycle Rack Extension (Low)**

8090167 Black  
8090168 Grey

⌀ 0.7 x 0.7 x 0.54

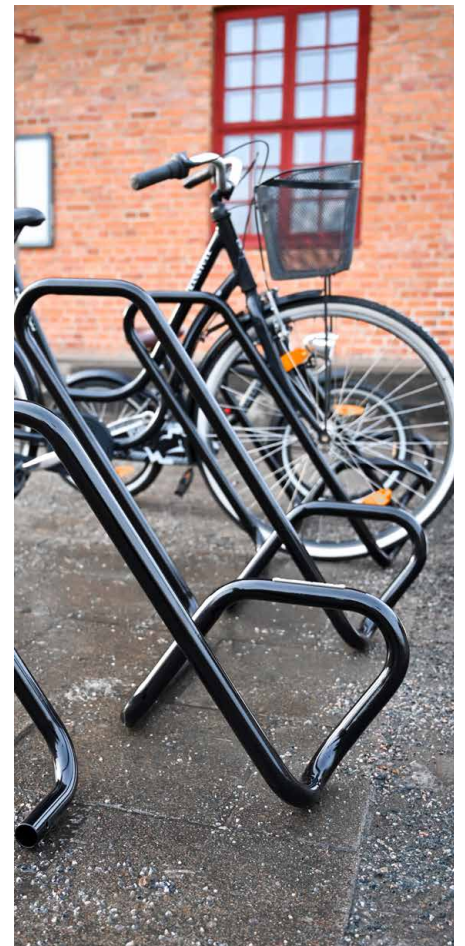





# PAVILIONS & PERGOLAS

Ensuring protection from the sun and rain in public spaces is essential for the comfort and welfare of both adults and children, while also serving as an attractive visual feature.

Our pergolas not only provide functional shelter but also make a striking impression. They can be utilized to enclose individual areas, adding a touch of distinction to any setting.



**Pergola 1 section**  
8063266 S Dark Brown  
⊗ 2 x 2 x 2,4



**Pergola 2 sections**  
8063260 S Dark Brown  
⊗ 4 x 2 x 2,4

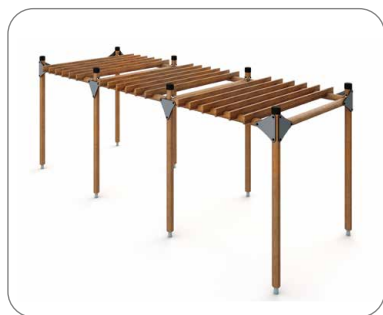

**Pergola 3 sections**  
8063258 S Dark Brown  
⊗ 6 x 2 x 2,4

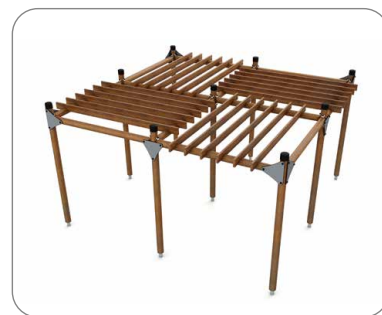

**Pergola 4 sections**  
8063245 S Dark Brown  
⊗ 4 x 4 x 2,4





19

**Palma Pavilion**

8030689 S Grey Posts, White Sides

☉ 4,8 x 4,2 x 3,16



17

**Miami Pavilion**

8020955 S Grey Posts, White Sides

☉ 3,2 x 3,7 x 2,9





# OUTDOOR ACCESSORIES

Accessories for outdoor areas such as products for traffic control and pedestrian safety and other practical everyday helpers in public areas.



## City-Form Barrier

8003107 Black, section + 1 post  
8003108 Black, End post, Ø 89 mm  
☛ 2 x 0,1 x 0,9



## City-Form Bollard

8003109 Black, Ø 89 mm with lock  
8003110 Black, Ø 133 mm  
8003111 Black Ø 133 mm, with lock  
☛ 0,09 x 0,09 x 0,9





**Parking space boundary** Running metre

8003546 **CC** 45x190, single  
 8003549 **CC** 45x143, single  
 8003552 **F** 45x143, single



**Parking space boundary** Running metre

8003556 **CC** 45x190, double  
 8003557 **CC** 45x143, double  
 8003554 **F** 45x143, double



**Post for parking space boundary**

8003541 *Galvanised, for 8003546/8003556*  
 8003542 *Galvanised, for 8003549/8003557*

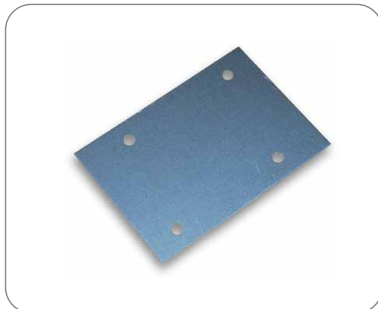

**Connection for parking space boundary**

8003543



**Concrete anchorage for car park border.**

8003544

⌀ 0,4 x 0,3 x 0,5



**Anchoring for Park Benches**

8025744 **S** *Galvanised, 1 pair*

⌀ 0,94 x 0,62 x 0,25



**Traffic limiter / bollard**

8012759 **CC** with integrated lock  
 8012763 **CC** for padlock

⌀ 0,09 x 0,09 x 0,9



**Ground cover cap for bollard**

8012762 *Galvanised, for bollards*

8012610 *Galvanised, for City-Form bollards*



**Barrier**

8012769 **CC** *Grey, 2,6 m*

8012770 **CC** *Grey, 1,6 m*

8012771 **CC** *Grey, 2,1 m*

⌀ 2,6/2,10/1,60 x 0,1 x 0,7



**Irrigation Tank**

8034919 E.g. for Flox planters



**Carpet Beating Rail**

8000674 **F** *Galvanised*

⌀ 3 x 1,15 x 1



**Christmas Tree Stand (with lid)**

8012717 **CC** *Galvanised, Ø 250 mm*

8012719 **CC** *Galvanised, Ø 150 mm*

⌀ 0,3 x 0,45 x 1,





# SHADE STRUCTURES

Shade systems are becoming more and more important in today's world of increasing UV levels, whether for children at play or for adults staying in one place for longer periods of time.

Our shade structures offer a robust and modern solution that can be used all year round and are adaptable to the environment and application.

Our shade structure customers come from a wide variety of areas including local councils, schools, shopping centres, hotels, airports or train stations.



Protection from sun and rain



Improved air circulation



Blocks up to 96% of UV-radiation



Reduction of up to 25 °C



Easy maintenance



10 year warranty











**Tension Sail**

4 posts / 1 fabric sail  
in: 6 x 6 m / Max: 12 x 12 m



**Mariner**

4 posts / 1 double-layer fabric cover  
in: 6 x 6 m / Max: 9 x 9 m



**Wave**

4 posts / 1 fabric cover  
in: 6 x 6 m / Max: 76 x 76 m

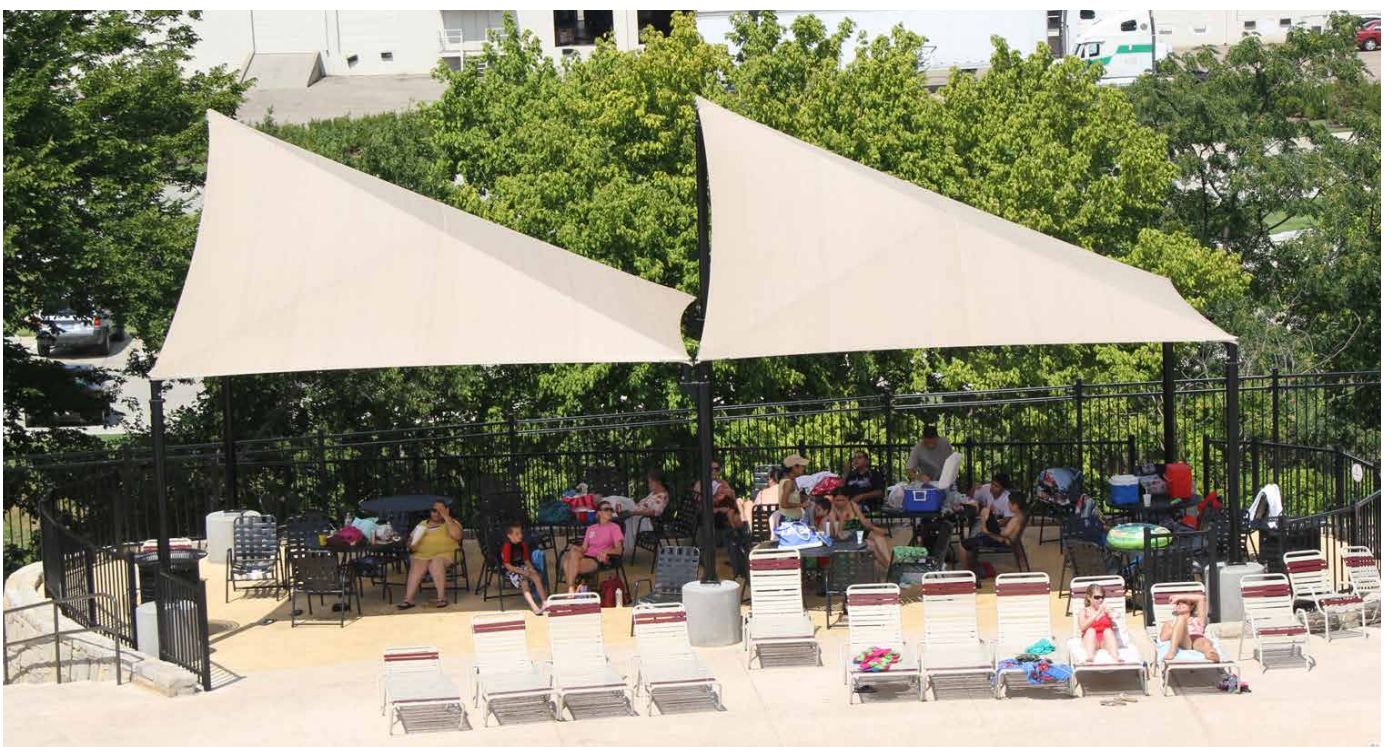





**Hip**  
4 posts / 1 fabric cover  
in: 3 x 3 m / Max: 12 x 12 m



**Full Cantilever**  
2 posts / 1 fabric cover / 2 cross brackets  
in: 6 x 4.25 m / Max: 9 x 6 m



**Single Post Cantilever**  
1 post / 1 fabric cover / 1 cross brace  
in: 3.65 x 3.65 m / Max: 4.25 x 4.25 m





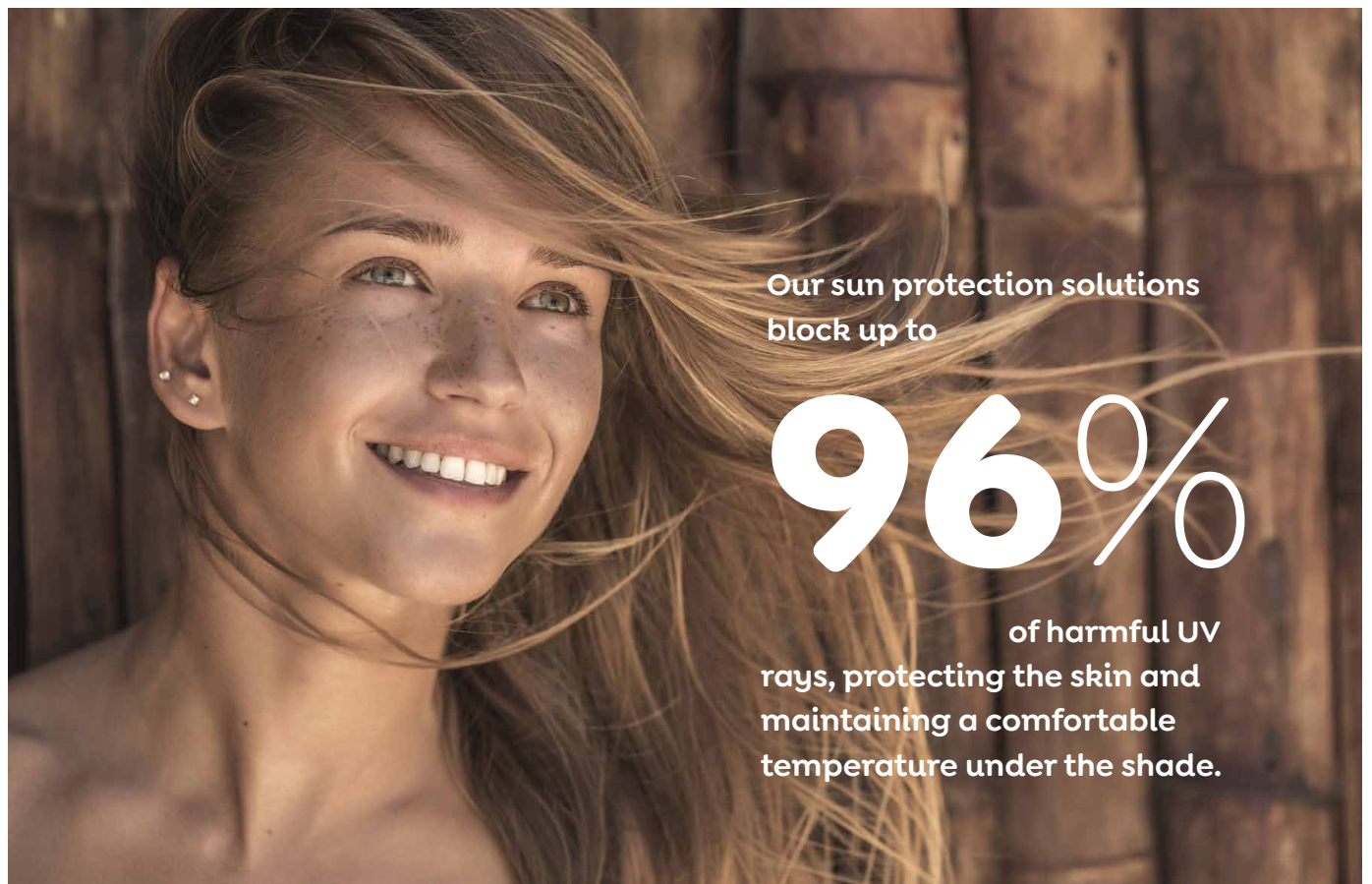

Our sun protection solutions  
block up to

# 96%

of harmful UV  
rays, protecting the skin and  
maintaining a comfortable  
temperature under the shade.

## Temperature Test

Based on example of current shade structure in Majorca in June

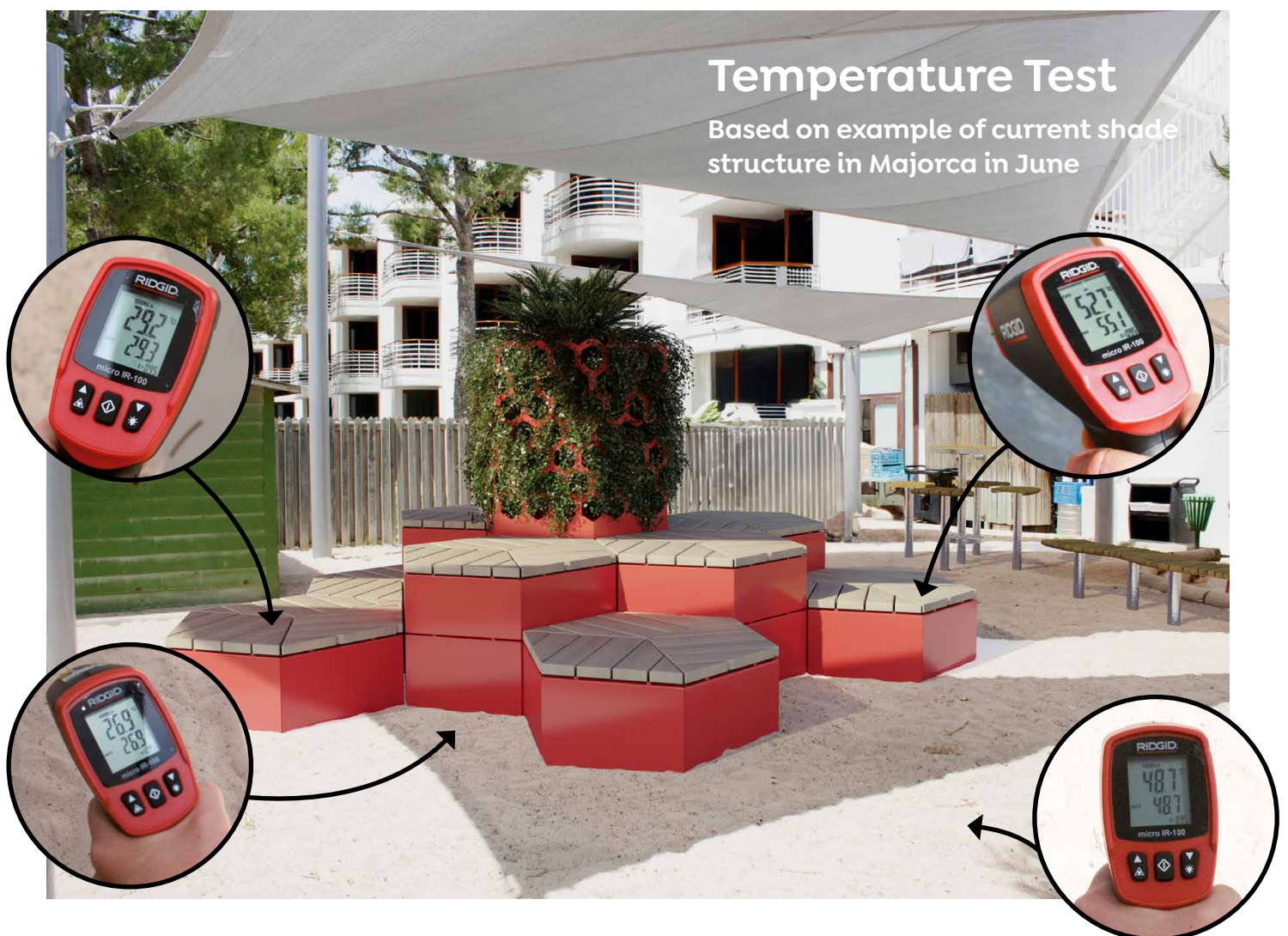

| Location               | Temperature (°C) |
|------------------------|------------------|
| Under the shade canopy | 29.7             |
| On a red planter       | 52.7             |
| On the ground          | 26.9             |
| On a wooden bench      | 48.7             |





## Transforms outdoor areas into UV-protected spaces.

- Micro-perforated fabric allows air to circulate in the shaded area, creating a much cooler atmosphere in this area.
- The fabrics are also made to withstand extreme winds and snow loads.
- All fabrics are covered by a 10-year manufacturer's guarantee.
- They are easy to maintain and clean. They have a service life of well over 10 years and are processed in such a way that the seams neither unravel nor tear.
- We offer a variety of different design concepts where the customer can choose the colours for both the fabric and the steel components.

### Steel Colour Options

|  |   |   |   |
|--|---|---|---|
|  |  |  |  |
| Black Grey<br>RAL7021  | Chocolate Brown<br>RAL8017  | Black Green<br>RAL6012  | Cobalt Blue<br>RAL5013  |
|  |  |  |  |
| Pure White<br>RAL9010  | Beige<br>RAL1001  | Zinc Yellow<br>RAL1018  | Signal Grey<br>RAL7004  |

The steel colours shown here in this brochure are for demonstration purposes only and are subject to the usual limitations caused by printing on paper and may therefore differ slightly in colour from the original. The fabric covers are available in a wide range of colours. We would be happy to advise you on your choice of colour. Please contact us if you require an original sample of the fabric or steel components.



# COLOURS



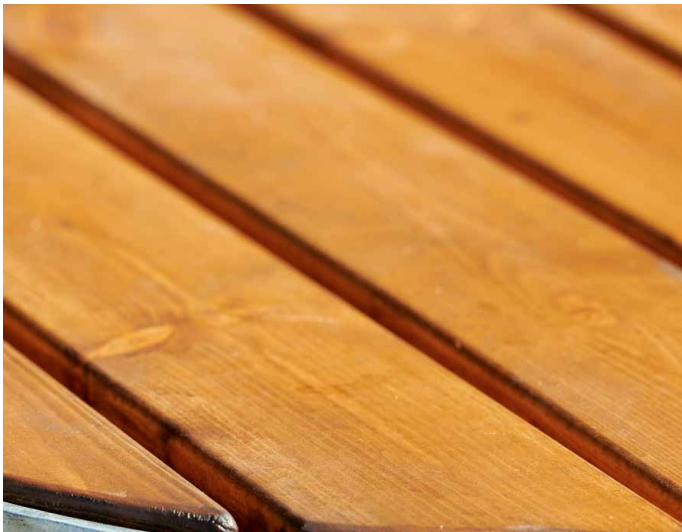









We recognise that each environment is unique, some require colours that blend in, while others need colours to stand out and create a bold statement. On these two pages you will find our standard colours. However, if you wish to tailor your furniture to align with your environment, we've got you covered.\*



## Steel (Powder coated)

- |  |   |
|--|---|
|  Carnival Red<br>NCS S 1580-Y90R      |  Rosenlund Blue<br>NCS S 3040- B10G  |
|  Rosenlund Red<br>NCS S 1070- Y90R    |  Rosenlund Green<br>NCS S 3040- B70G |
|  Pale Green<br>RAL 6021               |  Black Green<br>RAL 6012             |
|  Reseda Green<br>RAL 6011             |  Window Grey<br>RAL 7040             |
|  Pastel Green<br>RAL 6019             |  Titanium Grey<br>MW 112 F           |
|  Lime Green<br>BS 12E51               |  White Aluminium<br>RAL 9006         |
|  Forest Green<br>RAL 6029           |  Steel Grey<br>NCS S 3500-N        |
|  Spectrum Blue<br>NCS S 3060-R80B   |  Tornado Grey<br>NCS S 4500-N      |
|  Arena Blue<br>RAL 5002             |  Grey<br>NCS S 5000-N              |
|  Spectrum Yellow<br>NCS S 1070-Y10R |  Storm Grey<br>NCS S 6502B         |
|  Orange Yellow<br>NCS S 0585-Y30R   |  Anthracite<br>RAL 7016            |
|  Ruby Red<br>RAL 3003               |  Black<br>RAL 9005                 |
|  White<br>RAL 9010                  |   |

## Wood

- |  |  |
|--|--|
|  Teak Red<br>NCS S 4050-Y60R    |  Grey<br>NCS S 3005-G80Y          |
|  Park Green<br>NCS S 8010-B90G  |  White<br>NCS S 1502-Y            |
|  Bark Brown<br>NCS S 3030- Y10R |  Transparent White                |
|  Silver Grey                    |  Tar Black                        |
|  Red Brown<br>NCS S 2570-R      |  Moss Green<br>NCS S 5040-G50Y    |
|  Forest Green<br>NCS S 6030-G   |  Natural Brown<br>NCS S 1030-Y10R |





**HPL**

- |  |   |
|--|---|
|  Frog Green<br>NCS S 2060 G30Y    |  Antelope Brown (Beige)<br>NCS S 3010 Y30R |
|  Pastel Grey<br>NCS S 2500-N      |  Storm Grey<br>NCS S 6502-B                |
|  Carnival Red<br>NCS S 1580-Y90R  |  Pearl White<br>NCS S 0500-N               |
|  Spectrum Blue<br>NCS S 3060 R80B |  Saffron Yellow<br>NCS S 1050-Y20R         |
|  Pacific Blue<br>NCS S 2050-R90B  |   |

\*Subject to availability and surcharges. Contact your HAGS sales representative for exact colour options & lead times.

Actual colours may vary due to screen and print limitations.

**Colours are subject to change.**

**Concrete**

-  Grey
-  White

**Recycled Plastic**

-  Dark Brown



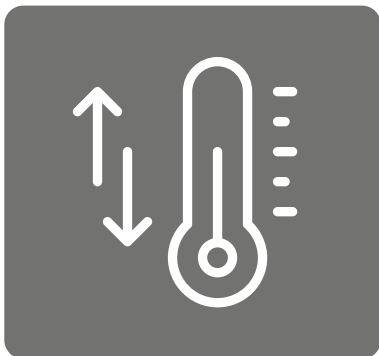

### Rust & Fade Resistance

Freezing temperatures in Scandinavia or the hot sun of the Mediterranean – our materials and finishes have handled it all without rusting or fading.



### Impact Testing

We test new materials to breaking point, even if it means hammer blows at -20°F, to ensure strength, durability, and safety.



### Weight Loading

We test each product to the appropriate EN standard to ensure it can support the weight of the user/s.



### Cycle Testing

We want everyone to enjoy uninterrupted use of our furniture, therefore we consider a variety of stress tests used during cycle testing to try and push a product to its limits.



### Vandalism Testing

We test all of our Park & Urban Furniture to the extreme to ensure they withstand all types of unexpected vandalism: welding torches, hammer blows, knife cuts – we test everything.







### Nordic Pine

Our FSC-certified pine wood comes from Scandinavian forests where the trees grow slowly and develop a very dense and compact quality.



### Steel

We only use structural steel, which is designed to withstand repeated use and heavy impact. This material undergoes a series of treatments that increase its durability and resistance.



### Hardwood

All our hardwood is FSC-certified and comes from responsibly managed forests. Our wood cutting process is fully computerised and reduces waste.



### Recycled Plastic

We use recycled polyethylene for our plastic park furniture.



Please note: Regular inspection and maintenance is recommended in line with HAGS Inspection and Maintenance Guides.



# HAGS<sup>®</sup>

**Oeko-Handels AG**

Spielgeräte & Parkmobiliar

Huebstrasse 42

CH-8545 Rickenbach ZH

Tel. +41 (0)52 337 08 55

[www.oeko-handels.ch](http://www.oeko-handels.ch)



**...wir bauen Spielplätze**